

USR-TCP232-T2 User Manual

File version: V1.1.1



Contents

USR-TCP232-T2 User Manual.....	1
1. Quick Start.....	4
1.1. Hardware Testing Environment.....	4
1.2. Connection.....	4
1.3. Default parameter.....	6
1.4. Data transport test.....	7
2. Overview.....	8
2.1. Brief Introduction.....	8
2.2. Features.....	8
2.3. Basic parameters.....	9
3. Hardware parameter.....	10
3.1. Pin define.....	10
3.1.1. Pin Definition.....	10
3.1.2. Dimension.....	12
3.1.3. Evaluation Kit.....	12
3.2. Hardware Reference Design.....	14
3.2.1. Typical Application Connection.....	14
3.2.2. Power Interface.....	14
3.2.3. UART Interface.....	15
4. Module function.....	15
4.1. Network basic function.....	16
4.1.1. IP address/ subnet masks/gateway.....	16
4.1.2. Web server.....	17
4.1.3. Firmware upgrade in webpage.....	18
4.2. Socket function.....	18
4.2.1. TCP Client.....	19
4.2.2. TCP Server.....	21
4.2.3. UDP Client.....	22
4.2.4. UDP Server.....	23
4.2.5. Httpd Client.....	24
4.2.6. TCP and UDP mechanism.....	26
4.3. DHCP and DNS Function.....	26
4.4. VCOM.....	28
4.4.1. Module Work as Client.....	28
4.4.2. Module Work as Server.....	29
4.4.3. Create VCOM.....	30
4.5. Serial port function.....	31
4.5.1. Basic parameters.....	31
4.5.2. Serial port framing.....	32

4.5.3. RFC2217.....	32
4.6. Special function.....	33
4.6.1. Heartbeat package.....	33
4.6.2. Registration package.....	33
4.6.3. USR-cloud.....	34
4.6.4. Customize webpage.....	36
4.6.5. Link.....	37
4.6.6. Reset.....	37
4.6.7. Index.....	37
4.6.8. The number of the connected client.....	37
4.6.9. State.....	38
4.6.10. Short connection.....	38
4.6.11. Clear buffer data.....	39
4.6.12. Restore out time.....	39
5. Parameter setting.....	40
5.1. Network protocol setting parameter.....	40
5.1.1. Setting software setting parameter.....	40
5.1.2. Protocol configuring to setting parameters.....	46
5.2. Webpage setting parameters.....	46
5.2.3. Serial port.....	49
5.3. AT comment.....	52
5.3.1. AT command overview.....	52
5.3.2. AT command error code.....	53
5.3.3. AT command.....	53
5.3.4. AT command.....	54
6.Contact us.....	67
7.Disclaimer.....	67

1. Quick Start

USR-TCP232-T2 is used for data bidirectional transparent transmission between TTL and Ethernet. T2 module itself complete protocol conversion, parameter can be set by built-in webpage or software. Once set permanent preservation.

This chapter is quick start for using USR-TCP232-T2 module, we advice users to read it carefully and operate personally, it can help you know about module generally.

Here is application case for inference:

<http://www.usriot.com/support/application-case/usr-tcp232-series-application-case/>

You can also email it to Customer Support Center:

<http://h.usriot.com/>

1.1. Hardware Testing Environment

To test T2 conversion function, user should connect T2 UART to computer by USB to TTL serial line, then connect T2 LAN port to computer LAN port by internet cable. If you want to use T2 evaluation board, use USB to RT232 serial line instead of USB to TTL serial line.



Diagram 1.1-1 Hardware Link

Note: The power and cable are from USR.

1.2. Connection

To prevent the thing that occur when the custom use it like can not find server, can not ping and can not open the webpage. After connect you should check the computer before used.

- 1) Shut down firewall and antivirus software.

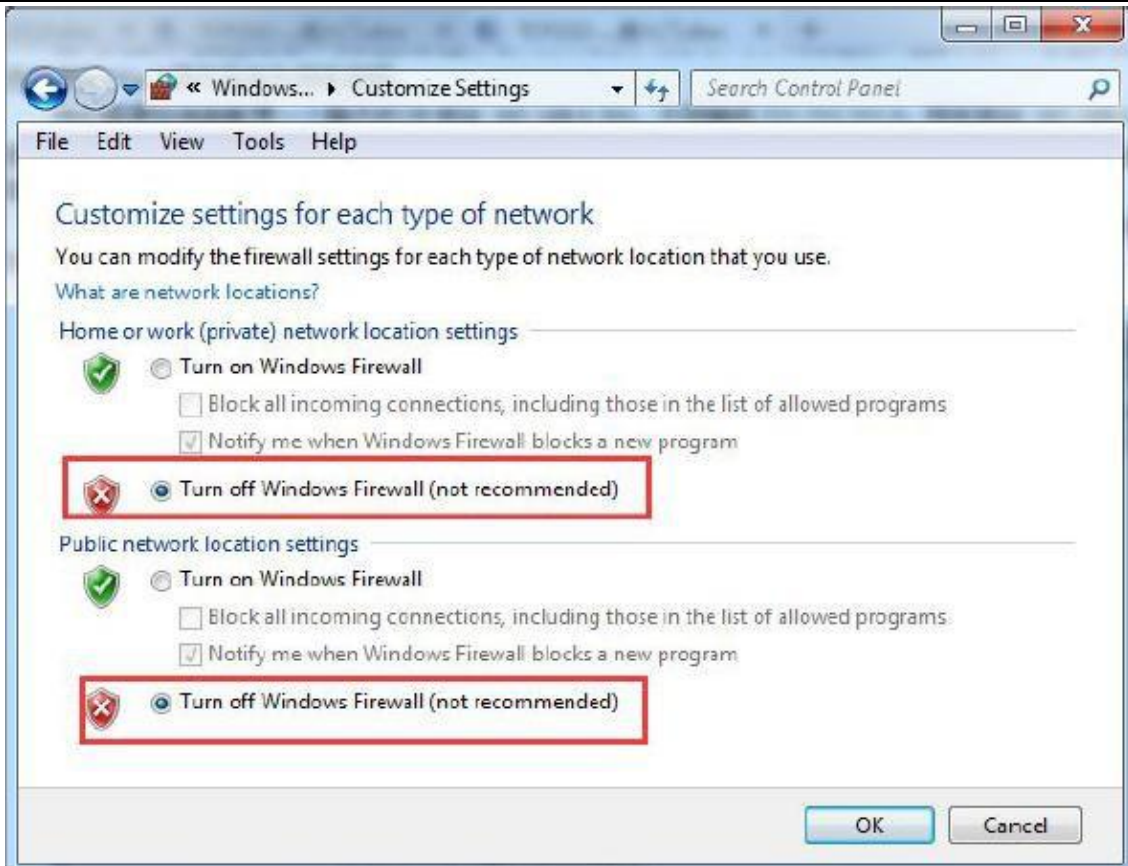

Diagram 1.2-1

2) Shut down network card none-related, reserve one connect.

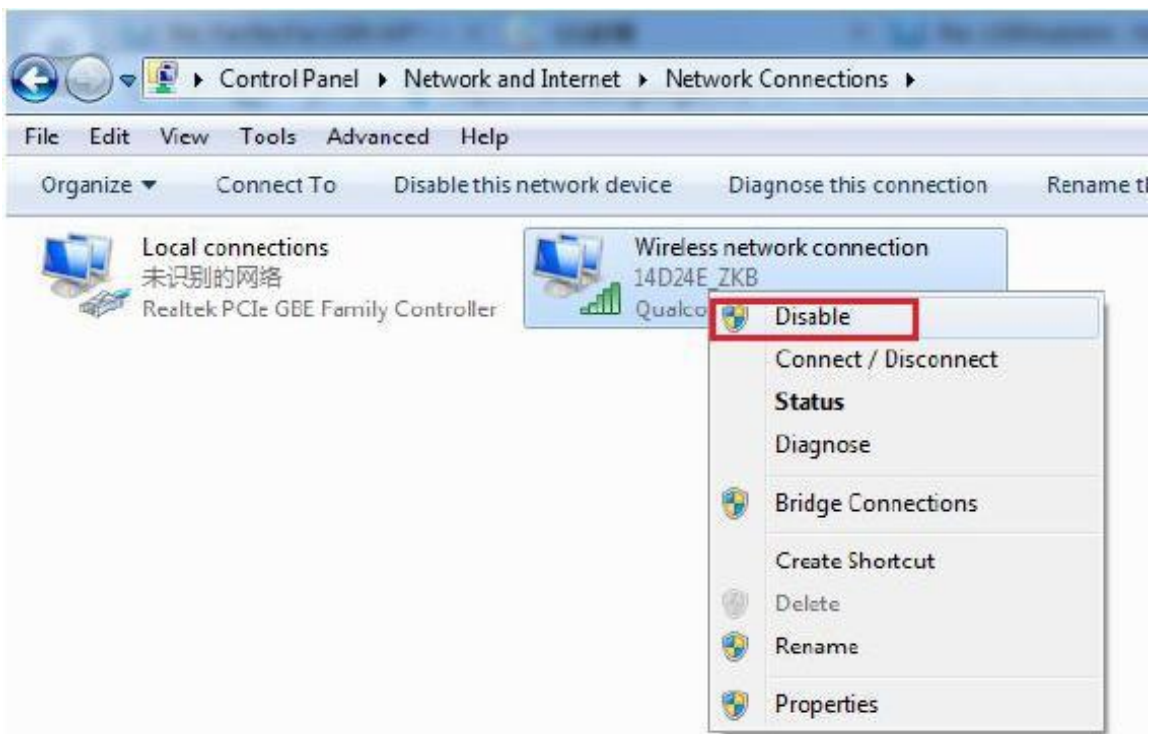

Diagram 1.2-2

3) If you want to connected module to PC directly, user should set static IP for computer which is in the same network segment with module.

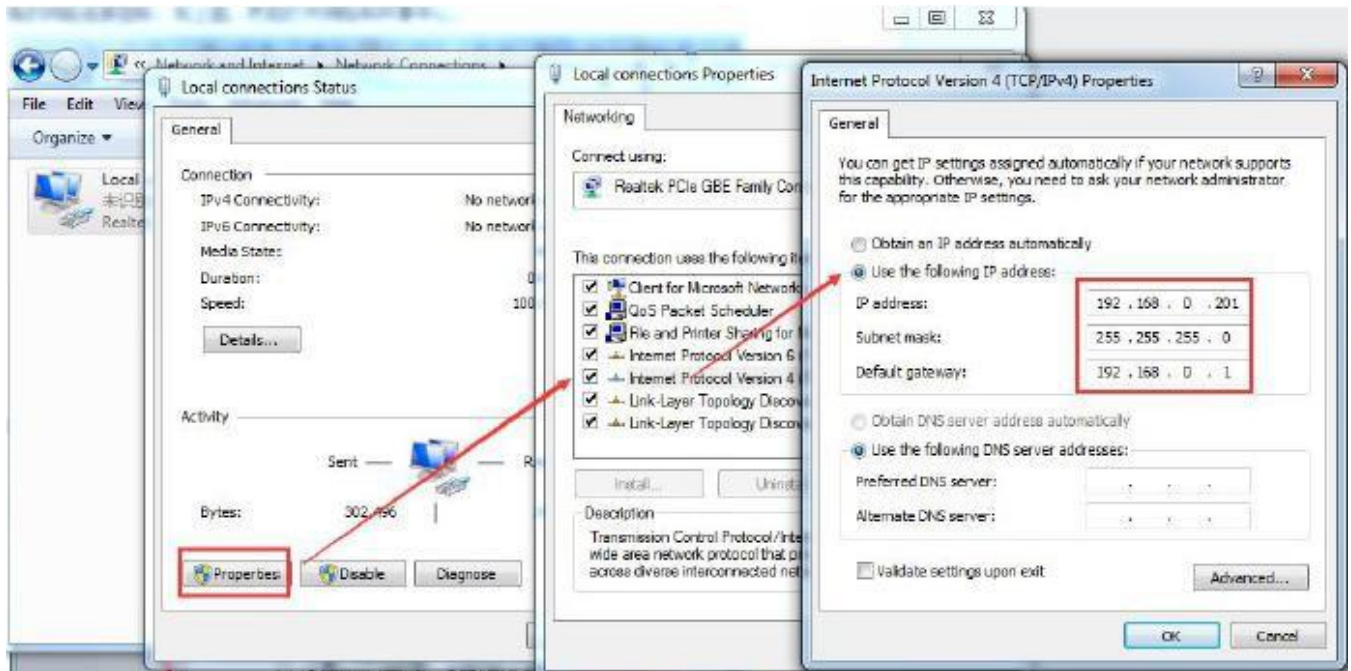

Diagram 1.2-3

1.3. Default parameter

Item	Intro
User name	admin
Password	admin
IP address	192.168.0.7
Subnet masks	255.255.255.0
Default gateway	192.168.0.1
Work mode	TCP client
Target port	8234
Local port	20108
Target IP	192.168.0.201
Serial port baud	115200
Serial parameter	None/8/1

Diagram 1.3-1 T2 Module Default Parameter

1.4. Data transport test

Steps for network communication parameters:

- 1) Install USR-TCP232-Test.exe .
- 2) Connect UART to PC, LAN to PC.
- 3) Protocol: TCP Server

Server IP: 192.168.201 (PC Static IP)

Server Port No: 8234

Baud rate:115200

Serial port parameters: None/8/1

From now, we can perform the send/receive data test. The direction from serial to network is: serial port of PC_> T2 serial port _> T2 ethernet port_>PC. The direction from net work to serial is: PC network _> T2 ethernet port_> T2 serial port _> serial port of PC

The diagram as below:

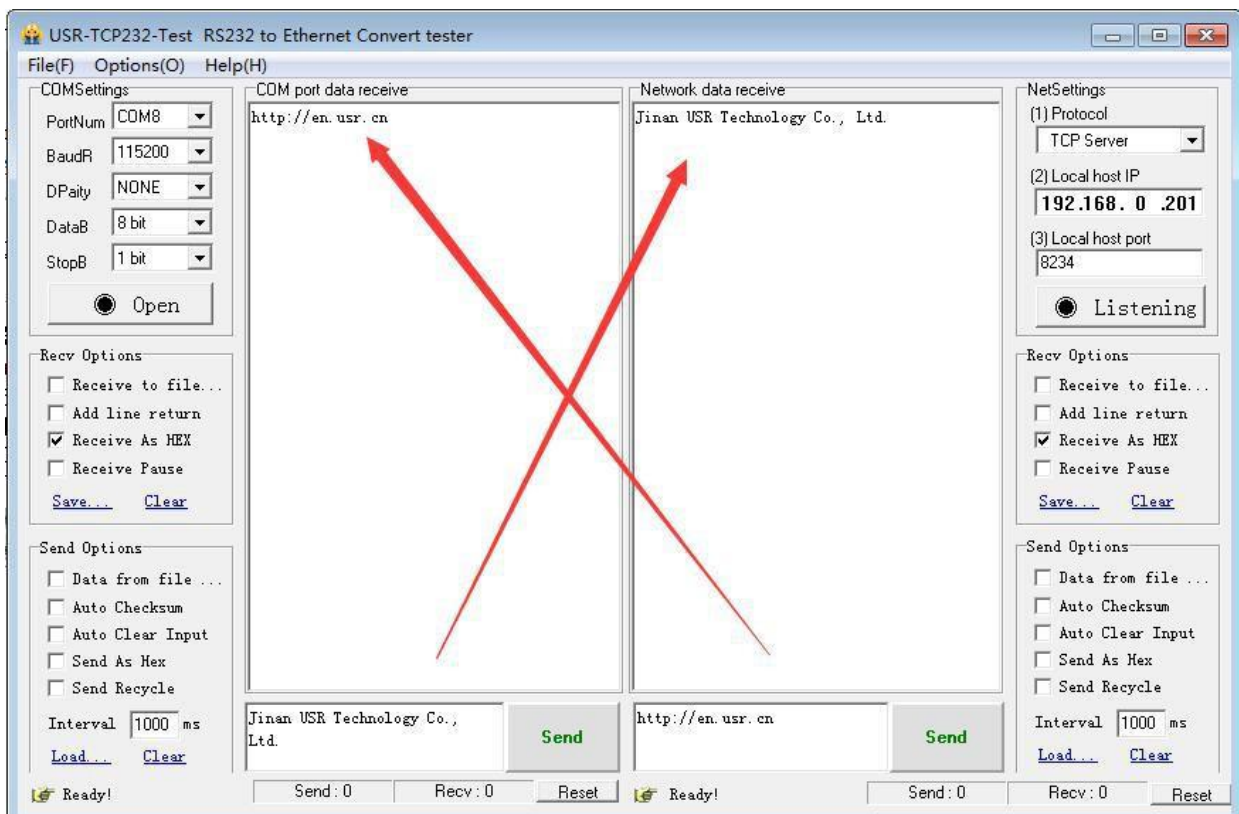

Diagram 1.4-1 Port to LAN Test

2. Overview

2.1. Brief Introduction

USR-TCP232-T2 is TTL to Ethernet module, which can realize the bi-direct data transparent transmission between RJ45 port and TTL serial port. It can be applied to interface 232 and 485 by level conversion circuit.

Equipped with Cortex-M0 core, fast speed and high efficiency. Support several function meet more need.

T2 module is easy to operate and has strong compatibility. On the basis of adding new functions, it is compatible with the setting protocol of T24 series to provide convenience for old users. At the same time, a setting protocol similar to M4 is added. For customers who adopt other series of products, it can be applied to T2 only by simple adjustment.

2.2. Features

- 10/100Mbps can adopted to Ethernet, support AUTO-MDIX switching of network cable crossovers.
- Work mode: TCP server, TCP client, UDP server, UDP client, Httpd client.
- Baud of the serial port can edit from 600bps to 460.8Kbps. Support five ways to check including None, Odd, Even, Mark, Space.
- Customize heartbeat package, keep the connection real and reliable, no crash.
- Customize registration package, check the connection status, and also customize the head of package, choose the MAC address to be the registration package.
- In TCP Server mode, the number of client connected can be modify from 1 to 16, default is 4. The IP of connected client can be see. Send and receive data according to connection calculation.
- In TCP Server mode, when the client number reach the max number, the new client can instead of the old one or not can be set.
- Support webpage, AT command, serial port protocol, webpage setting parameter, setting protocol. Provide custom to use in their own software.
- Support TCP client short connection, the time can be set.
- Support reset out time, the time can be set.
- Before the TCP connect, whether clear the data before can be set.
- Support DHCP, get IP automatically
- The unique MAC address in the world, and the address can be modify. Support the function of customize MAC.
- Support DNS, domain name resolution.
- Support customize the address of DNS server.
- Support upgrade the firmware from webpage, more convenient.
- Support v-com
- Support across the gateway, switching and router
- Support work in LAN, also can access the external.

2.3. Basic parameters

Hardware parameters	
Work voltage	VCC: DC 3.3V, 3.15V~3.45 V VDD: DC 5V, 4.75V~5.5V
Run current	150mA@5V/3.3V
LAN port	RJ45 with electromagnetism isolation
Serial baud rate	600-460.8K (bps)
Serial standard	TTL-3.3V
Software parameters	
Network protocol	IP, TCP/UDP, ARP, ICMP, IPV4
Method of IP access	Static IP, DHCP
Domain name solution	Support
User setting	Software setting, webpage setting, AT command setting
Simple transparent transport	TCP server /TCP client/ UDP server / UDP client
RFC2217	Support
Httpd client	Support
TCP server	Max number of connected TCP is 16(can customize)
Network cache	Send: 6Kbyte; receive: 4Kbyte
Serial cache	Receive:800byte
Average transport delay	<10ms
Set of software	V-COM; USR- cloud; parameter setting
Packaging mechanism	4 byte packaging time; 400 byte packaging length
Others	
Certification	CE, FCC
Size	50.5*22.6*15.0 mm (L*W*H)
Temperature	Working temp: -25 ~ 75 °C Storage temp: -40 ~ 105 °C Storage humidity: 5% ~ 95% RH
Packaging	Electrostatic bubble

Diagram 2.3-1 USR-TCP232-T2 Parameters

3. Hardware parameter

3.1. Pin define

3.1.1. Pin Definition

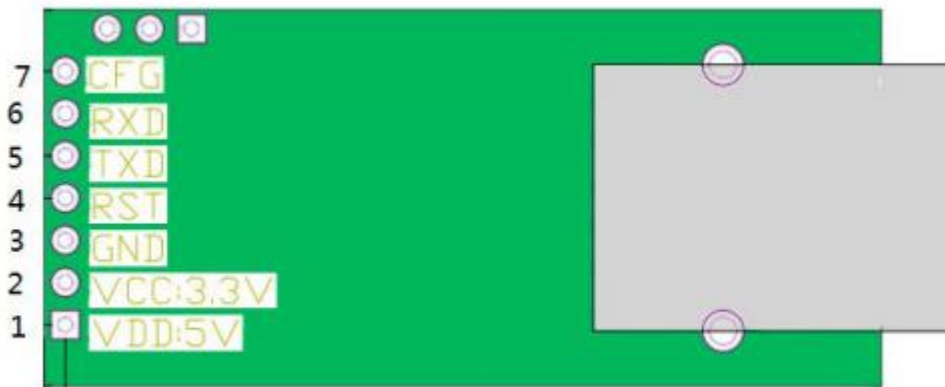

Diagram 3.1.1-1 T2 Interface Definition

NO	Pin	Function	Instr
1	VDD	Power	Power: 5V@200mA
2	VCC	Power	Power: 3.3V@200mA
3	GND	Ground location	Grounding
4	RST	Reset	Pin receive current below 200ms ,it can reset module. If unneeded, don't connect the pin . (Power on , reset means restart the module)
5	TXD	Send data	TTL connect to 3.3v MCU (For 5V, refer to Diagram 3.1.1-2)
6	RXD	Receive data	TTL connect to 3.3v MUC (For 5V, refer to Diagram 3.1.1-2)
7	CFG (reload)	Pin for module configuration and restore factory default	When normal working , don't connect the pin or connect to high level. Under low level, the pin is used for module configuration, access to power then pull down "Reload" pin Refer to 4.4.3 Factory Reset

Form 3.1.1-1 T2 Pin Definition

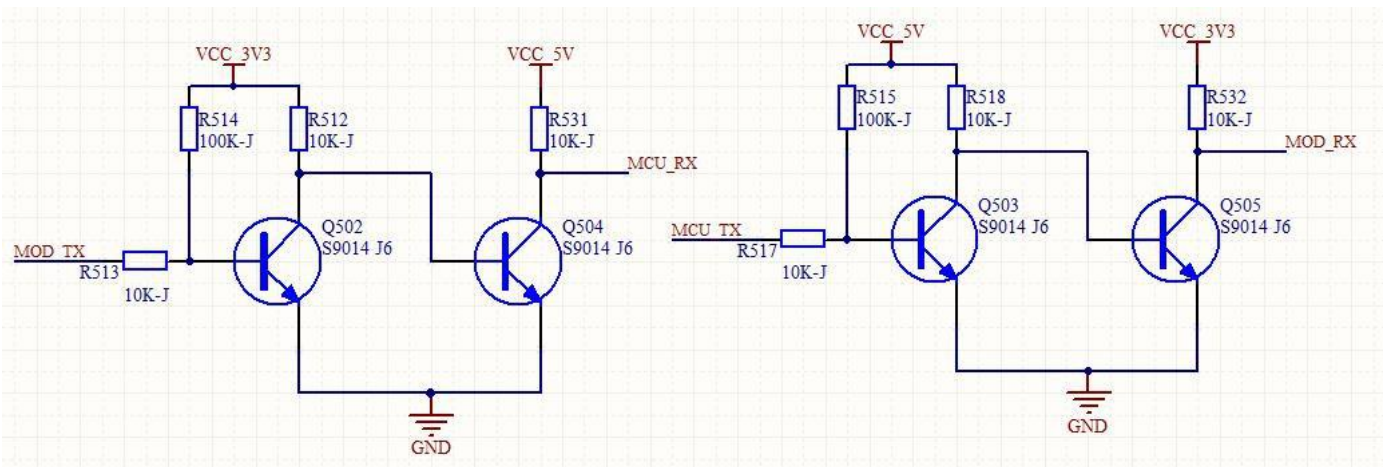

Diagram 3.1.1-2 3.3V to 5V voltage conversion circuit



Diagram 3.1.1-3 Reserved Pin

1	485-en	Reserve pin	RS485 enable pin
2	Link	Reserve pin	Used as indication pin for TCP connection status. Refer to 4.4.2 Link Function
3	ISP	Reserve pin	Hasn't use

Form 3.1.1-2 T2 Reserved Pin Definition

3.1.2. Dimension

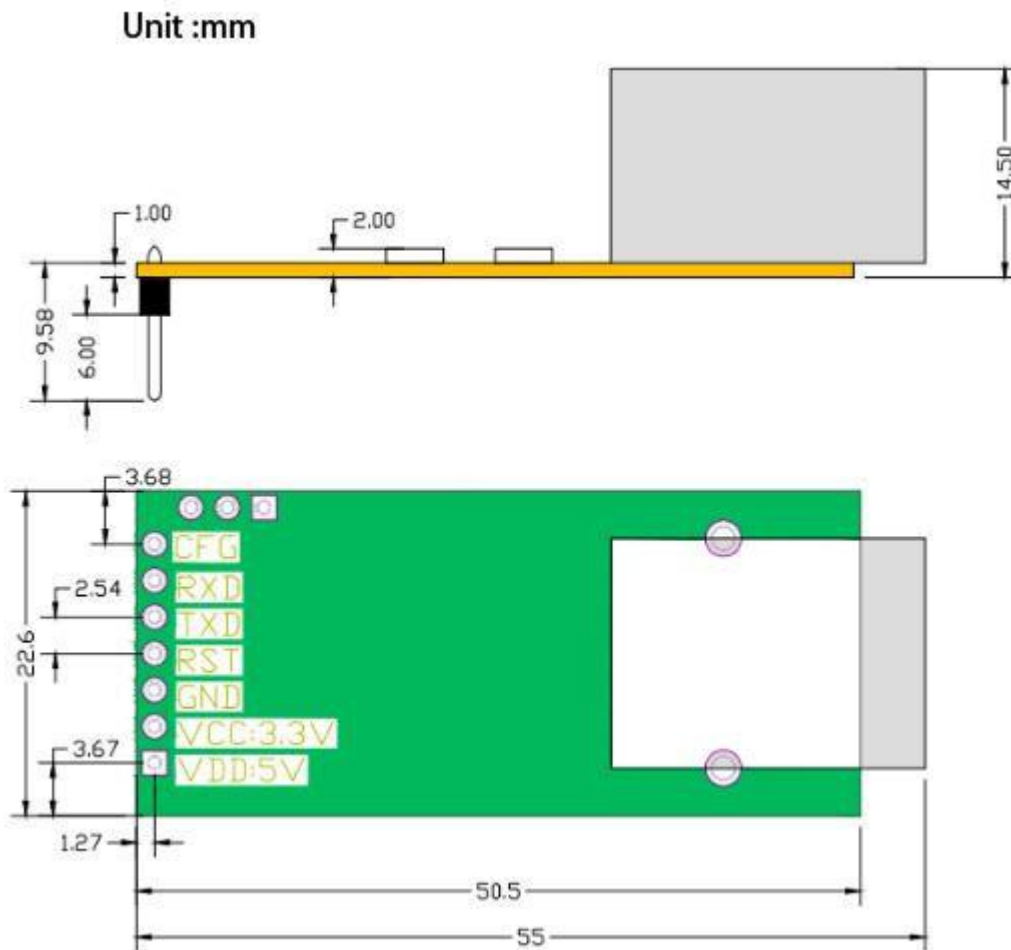

Diagram 3.1.2-1 T2 Dimension

3.1.3. Evaluation Kit

USR-TCP232-EVK evaluation board can be used for TCP232-T2

3.2. Hardware Reference Design

3.2.1. Typical Application Connection

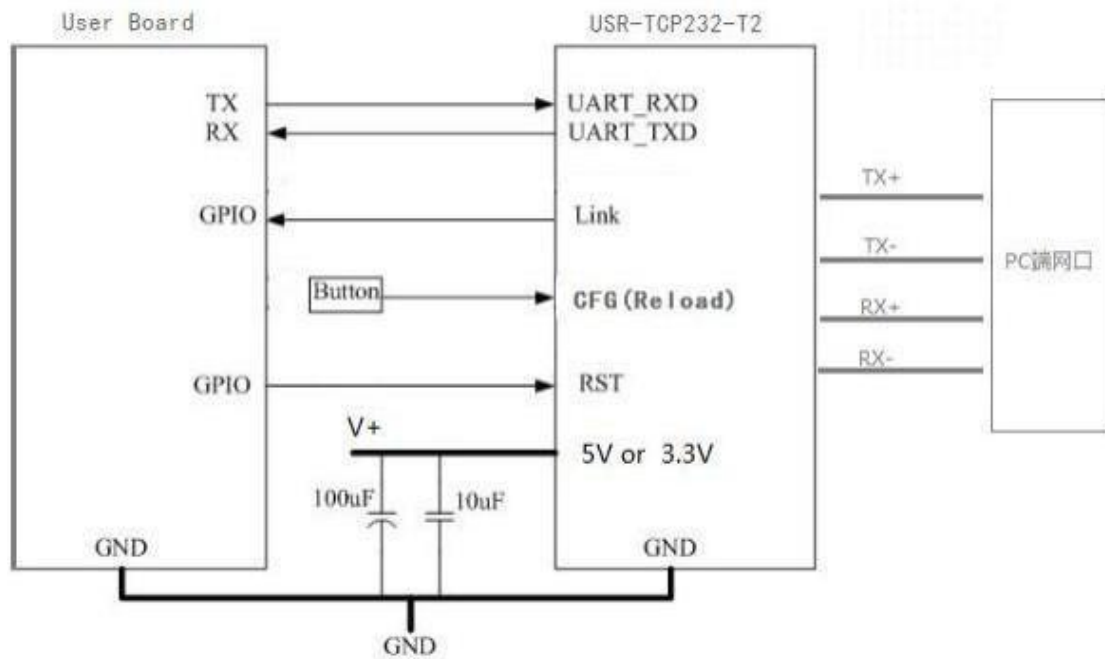

Diagram 3.2.1-1 Typical Application Connection

Note:

- 1) RST: Restart button. It works at low level, 3.3V, 10K pull-up resistor inside. When it access to power or breakdown, pull down 300ms then high level.
- 2) Link: connection indication. Can be used as indication pin for net connection, when connected, it outputs low level; When unconnected, it output high level.
- 3) CFG(Reload): connect to external button or configuration pin. 3.3V, 10K pull-up resistor inside. Press it and pull to low level, then release hands after 3 seconds, module restores factory default and restart.
- 4) UART_TXD/RXD: data send/ receive signal(10K pull-up resistor inside)

3.2.2. Power Interface

USR-TCP232-T2 has dual power supply interface, 5.5 v and 3.3 v (only choose one) Working current 150 mA, max current 200mA .

VCC: typical value DC 3.3V, 3.15V~3.45 V. It is used for 3.3 V MCU.

VDD: typical value DC 5V, 4.75V~5.5V. When connect to 5V MUC, **refer to Diagram 3.2.3 -2 3.3V to 5V voltage conversion circuit**

3.2.3. UART Interface

UART can connect RS232 chip, UART has TXD/RXD signal wire. Take RS232 Level for example.

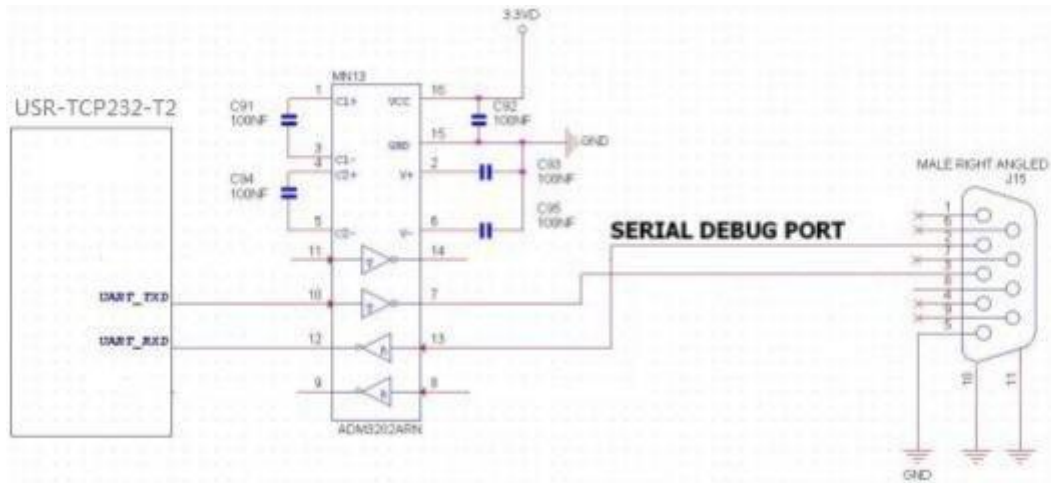

Diagram 3.2.3-1 UART Interface Design

If communicated with MCU (3.3V TTL), connect module's TXD to MCU'S RXD, modules' RXD to MCU'S TXD. If MCU 5V TTL, need voltage conversion circuit, as follows:

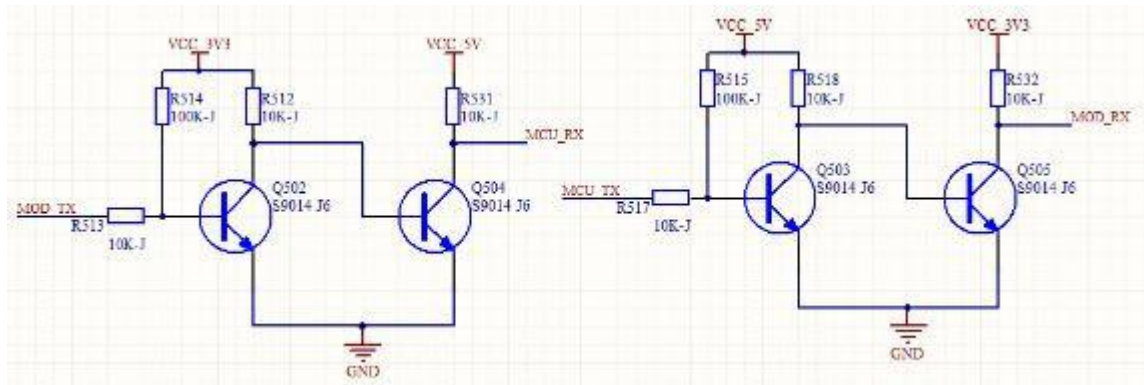

Diagram 3.2.3-2 UART Level Switch Design

4. Module function

Here are the function of T2, below is the overall block diagram.

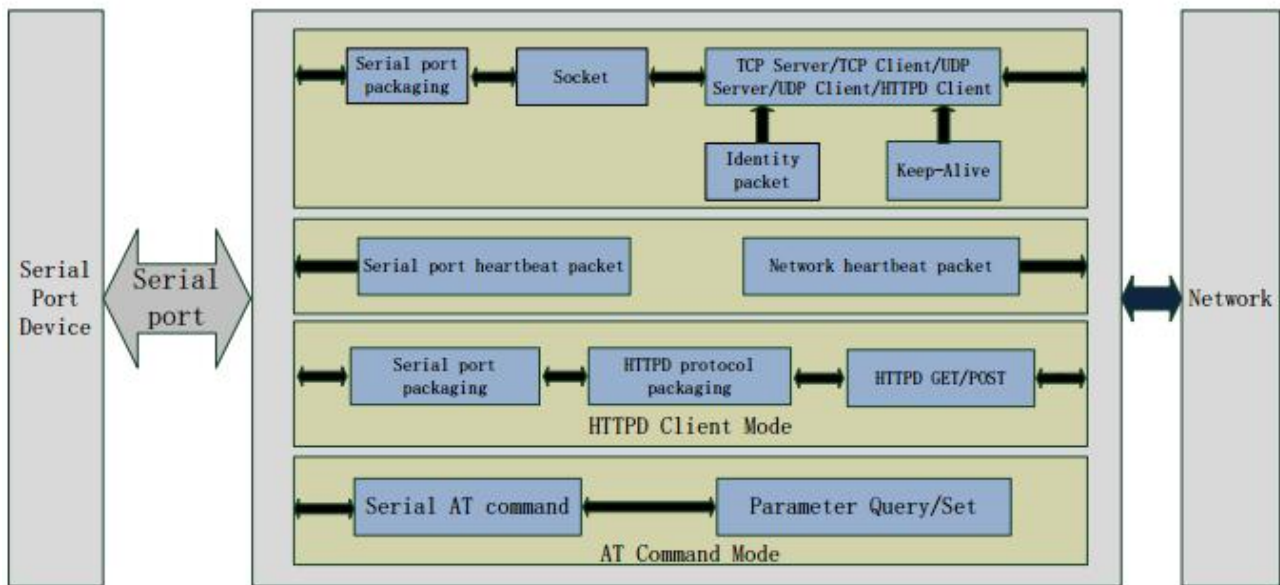

Diagram 4-1 Module Functions

4.1. Network basic function

4.1.1. IP address/ subnet masks/gateway

1. IP address is the identity representation of the module in the LAN, which is unique in LAN. So it can not be repeated. There are two ways to access the network: static IP and DHCP.

- Static IP

Static IP need to be setting handy. Meanwhile write the IP, subnet masks and modbus gateway. Static IP can be used in.

Advantage: can be searched when the device accesses the IP that can not distribute.

Disadvantage: can not communicate if the device in the different port of the different LAN

- DHCP

Main function is get the IP address, gateway address, DNS server address from the gateway holder, and no need for the complex steps. Adopted to the situation have little requirement for IP and do not ask the IP to corresponds to module.

Advantage: access the devices that support DHCP server like router can communication directly. Reduce the trouble of setting IP address gateway and subnet masks.

Disadvantage: directly to the computer in the net do not support the DHCP server, T2 can not work

2. Subnet masks mainly used to determine the host number and the network number, indicates the number of subnet and determine the flag within the subnet. The subnet masks needed to set, usually we use the subnet masks: 255.255.255.0, the network number is the former 24, the holder name is the last 8, number of subnet is 255, the module IP is in the range of 255, and then we are sure that the module IP is in this subnet.

3. Gateway means the net number of the current IP that module in. If connect the device like router when access the external, the gateway IP is the router IP, if there is some thing wrong with setting, can not access the external net. If no need to connect the router, keeping default is ok.

4. Reference AT command

command name	Instr
AT+WAN	Setting and query the access way of T2 IP, IP/subnet masks/gateway parameter

Form 4.1.1-1 AT command

5. Software setting:

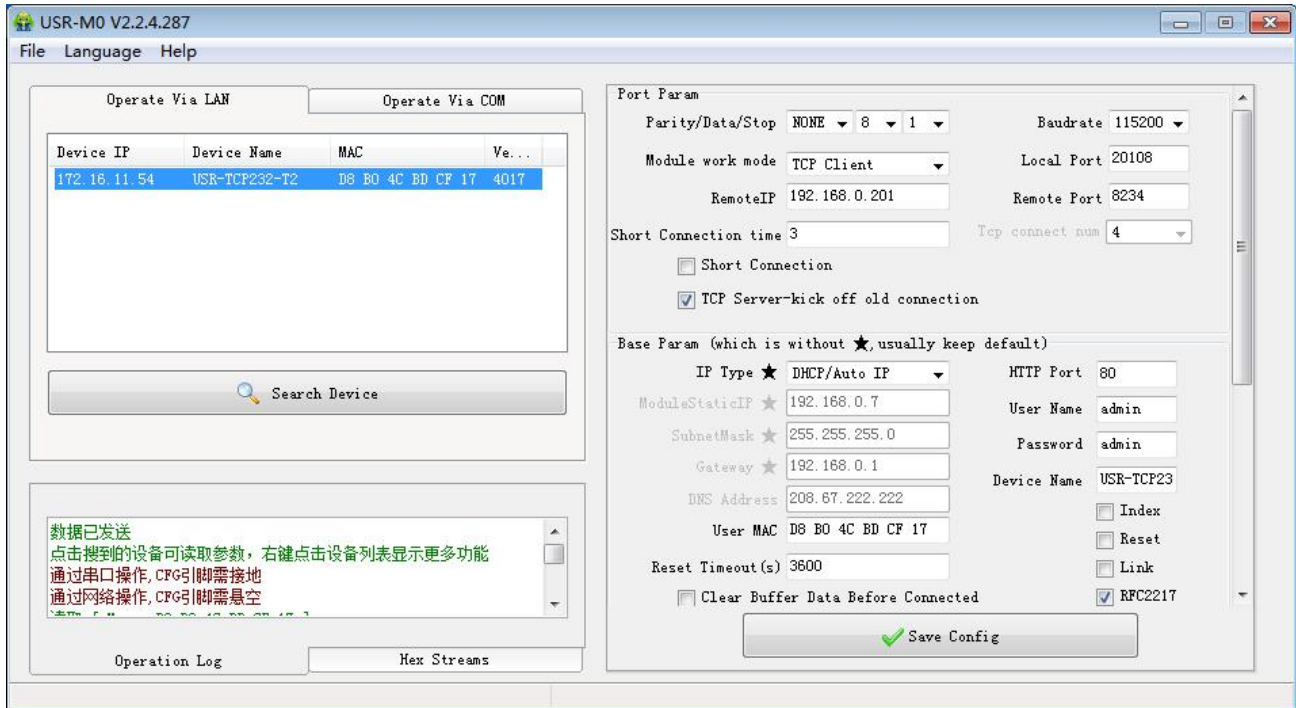

Diagram 4.1.1-1 Software Setting

4.1.2. Web server

T2 has its own webpage server, same as the normal webpage server, which is convenient for user to setting parameter and query the status of T2.

The port of webpage can be setting, default is 80.

Steps:

- ◆ Open the browser, fill the IP of T2, e.g.:192.168.0.7(IP address and PC in the same net.)
- ◆ Fill the user name and key word in the login webpage, default is admin, click the sure and enter.

Then there is the status webpage:

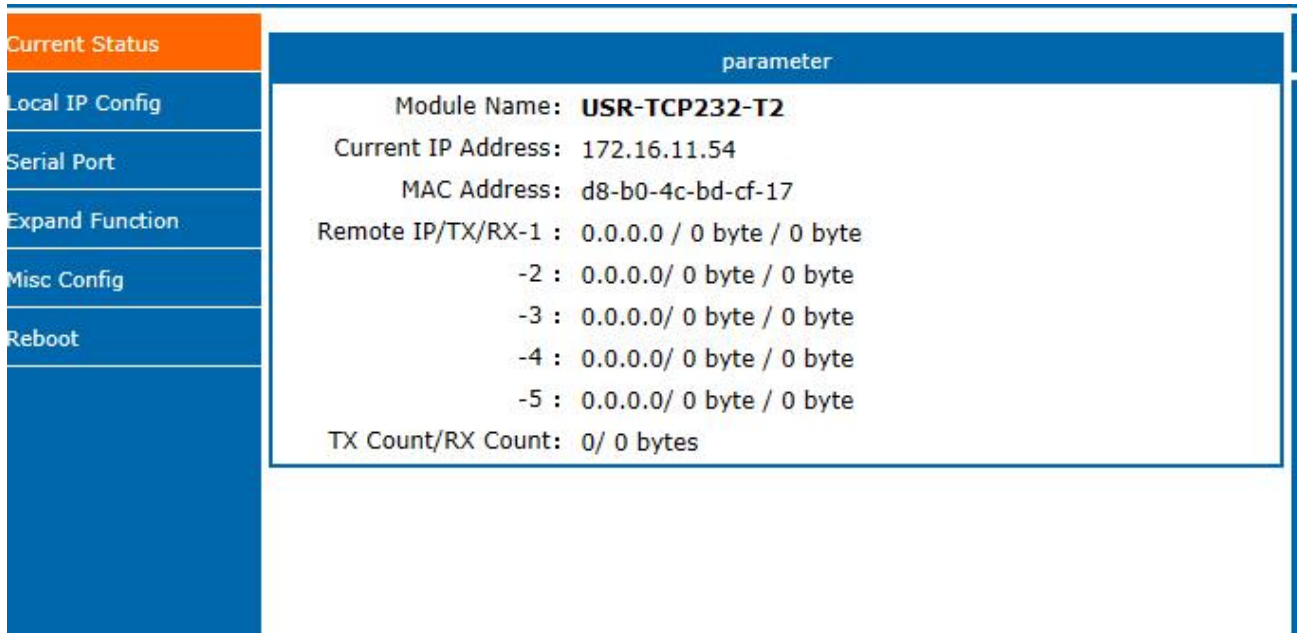

Diagram 4.1.2-1 Webpage

4.1.3. Firmware upgrade in webpage

Webpage upgrade the firmware, stable and simple. Use this new function, meet the custom requirement. If you need to upgrade, you can query us from the USR support or ask firmware from supply. **The way to upgrade please refer the 5.1.1.**

4.2. Socket function

The work mode for T2 divide into five: TCP Client、TCP Server、UDP Client、UDP Server、Httpd Client. You can use webpage and setting software. The page is as follows:

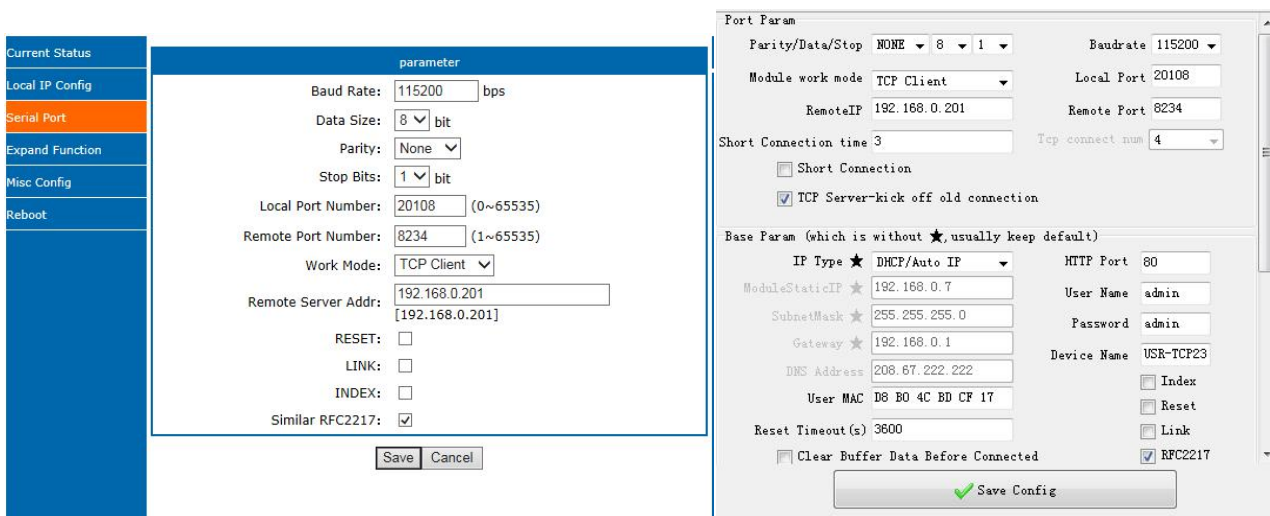

Diagram 4.2-1 Socket

Related AT command

command name	Instr
AT+sock	Setting the work mode/target IP/ target port

Form 4.2-1 socket AT command

4.2.1. TCP Client

It has to be connected before transferring data.

1) In TCP Client Mode, TCP232-T2 connects TCP Server actively, establish a connection to transmit data. According to the TCP protocol related rule, there difference for TCP client between connect and disconnect, to make sure the data exchange more stable. Usually used in the data interaction between device and server, which is the most common form of network communication.

2) In TCP Client Mode, support the function of identifying disconnected link. When connected, it will send keepalive package every 15s. If unconnected, it can be detected timely and enforce T2 to disconnect the former link to establish a new one.

3) When TCP232-T2 try to connect remote server, if the local port number is not "0", it will establish a connection with the same source port every time.

4) Support synchronizing baud rate, USR-cloud and short connection function.

5) In a LAN, if the T2 is static IP, please keep T2 IP stay in the same network segment with gateway, and setting the gateway IP, otherwise can not work as normal.

6) Note: keepalive, synchronizing baud rate and USR-cloud are more on the below.

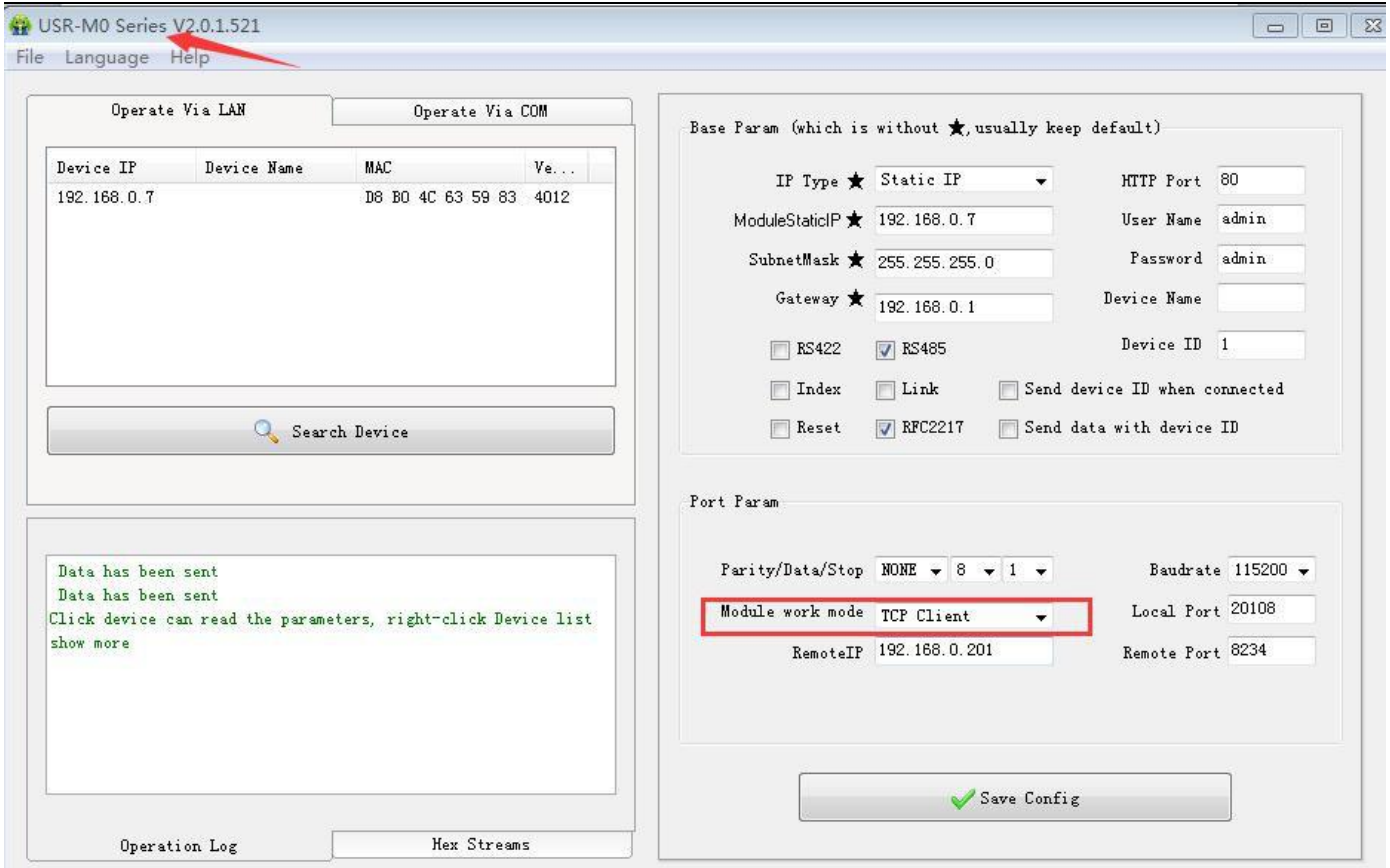

Diagram 4.2.1-1 TCP Client Setting

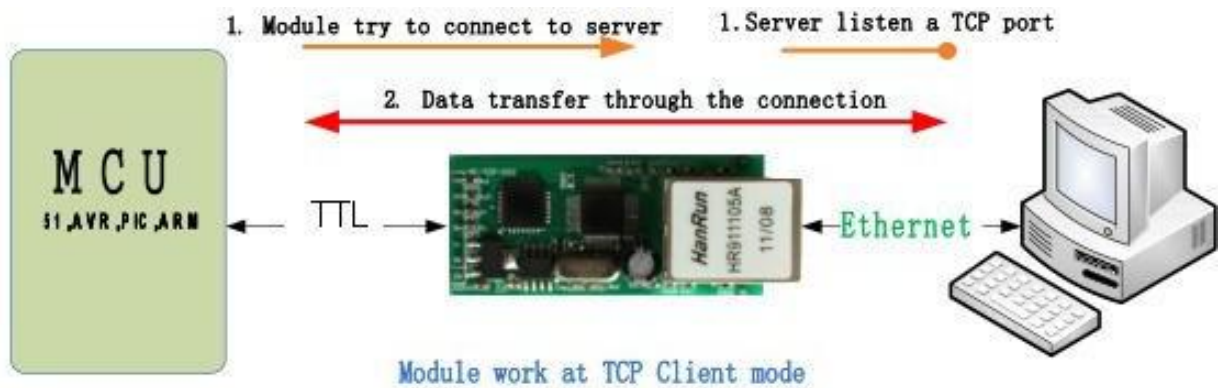

Diagram 4.2.1-2 TCP Client Model

4.2.2. TCP Server

- 1) In TCP Server Mode, T2 monitors local port, it will response and establish a connection when there is a request. When the T2 receive the data, it will send it to all the client connected to T2, meanwhile, this mode can monitor the connect timely with keepalive function.
 - 2) Usually it is used in the LAN communicating with TCP client. Adopt the case that more than one PC or phone asking data without server. Same as the TCP client ,there are different between connect and disconnect.
 - 3) Support synchronizing baud rate.
- TCP Client number is from 1 to 16, default value 4. the port is fixed., can not be set to 0.

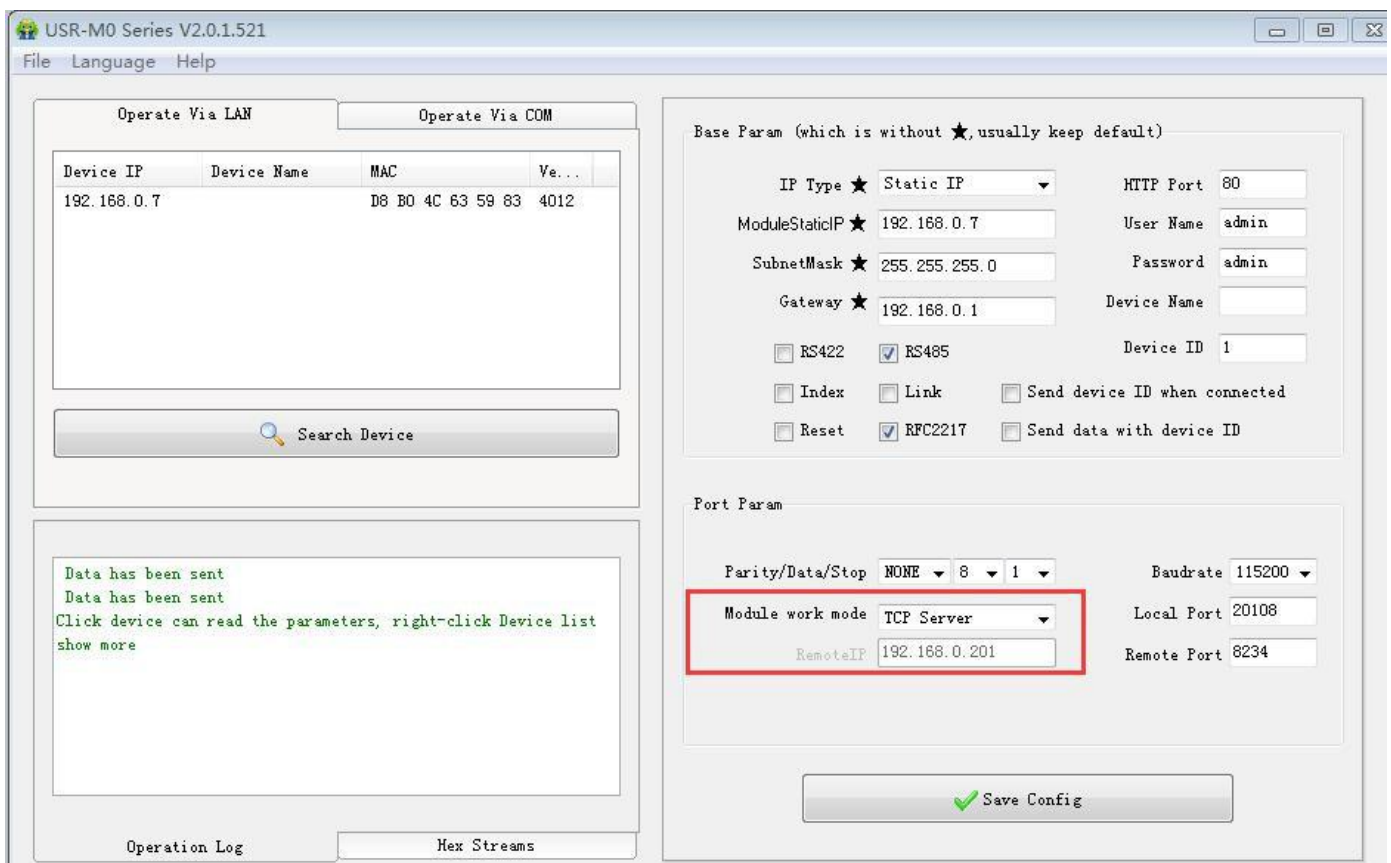

Diagram 4.2.2-1 TCP Server Setting

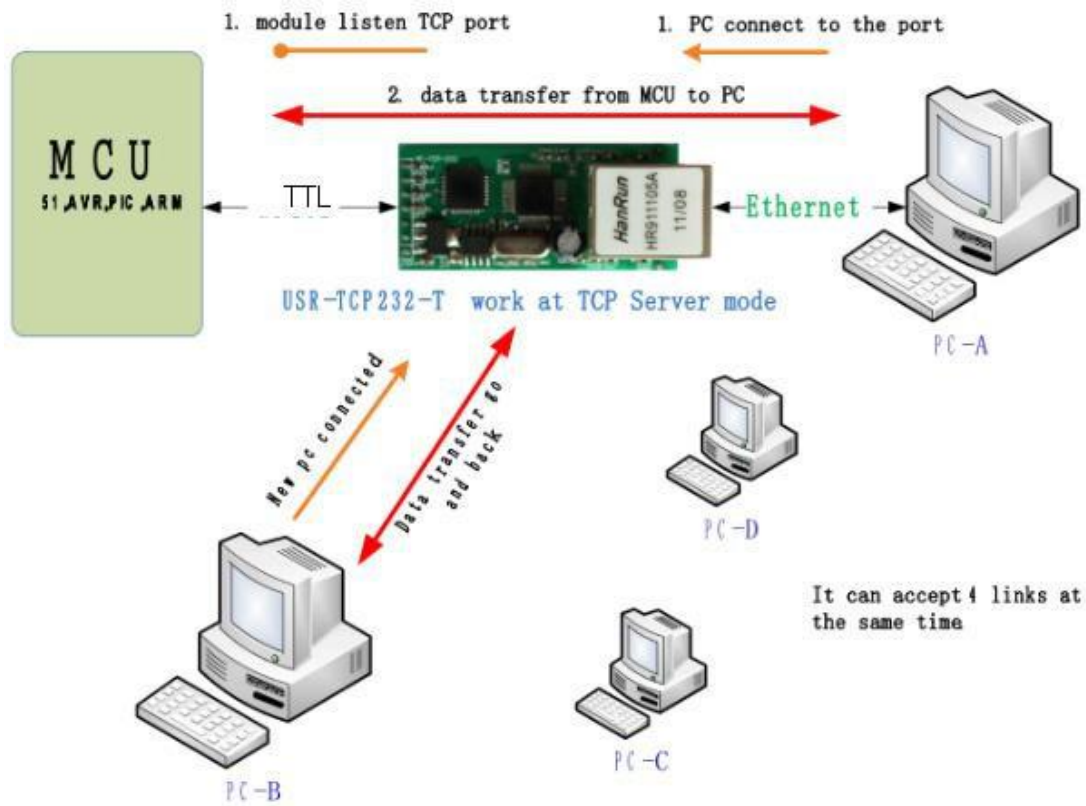

Diagram 4.2.2-2 TCP Server Model

4.2.3. UDP Client

- 1) The Model belongs to UDP Protocol.
- 2) In UDP Client Mode, TCP232-T2 won't establish the connection actively.
- 3) It can communicate with the target port whose IP has been set. If data doesn't come from this channel, it will not be accepted by TCP232-T2.
- 4) In UDP Client Mode, if target IP is set as 255.255.255.255, it can realize function of entire network broadcast, also can receive broadcast data. 4015and the later vision support broadcast. e.g.xxx.xxx.xxx.255

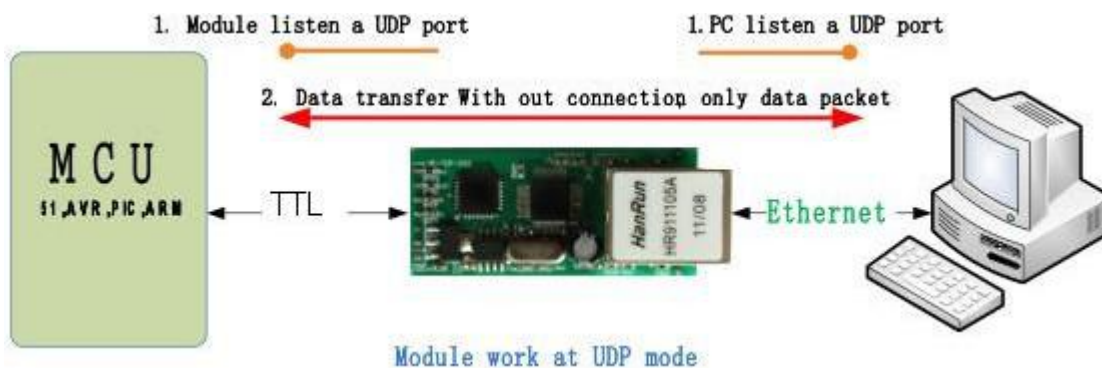

Diagram 4.2.3-1 UDP Client Model

4.2.4. UDP Server

- 1) UDP server is a IP address do not verify the resource in the normal UDP. After receive every UDP package, change the target IP into data resource IP and port. When sending data, sending to the least IP and port.
- 2) Usually this mode, several net device communicate with module and do not want to use TCP for high frequency.

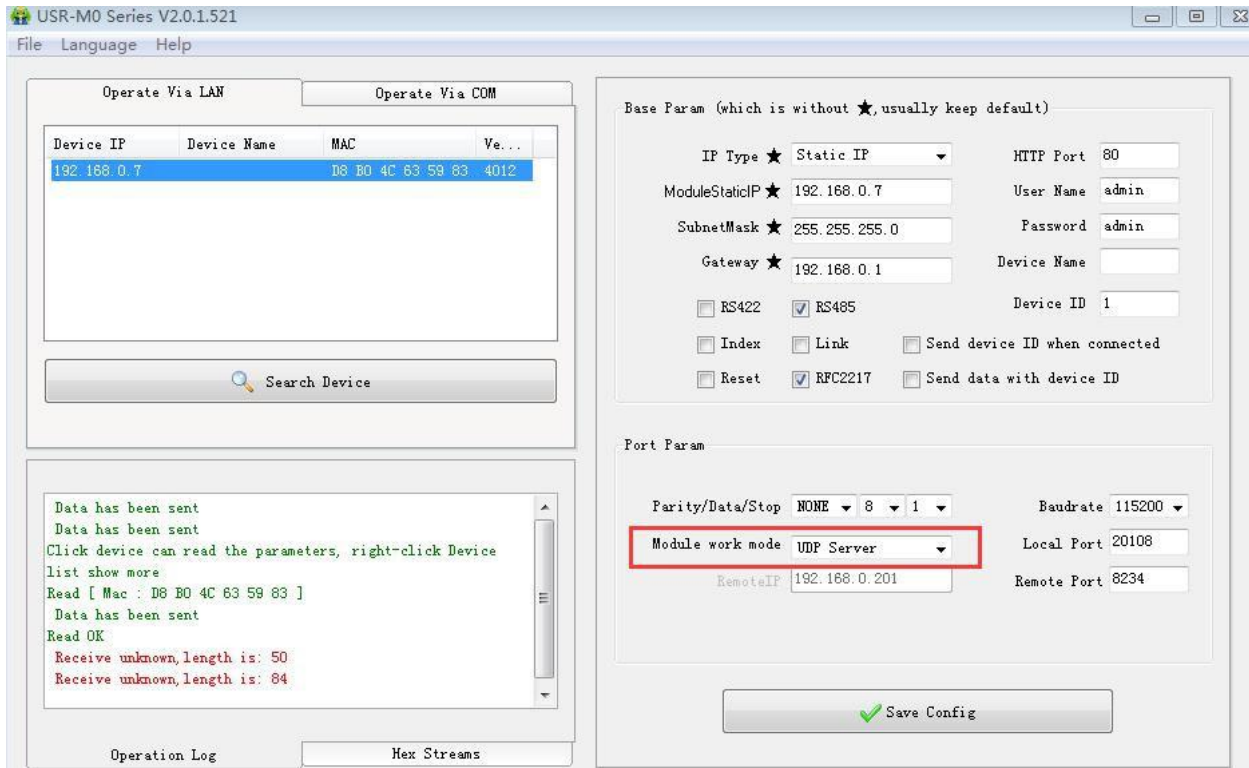

Diagram 4.2.4-1 UDP Server Setting

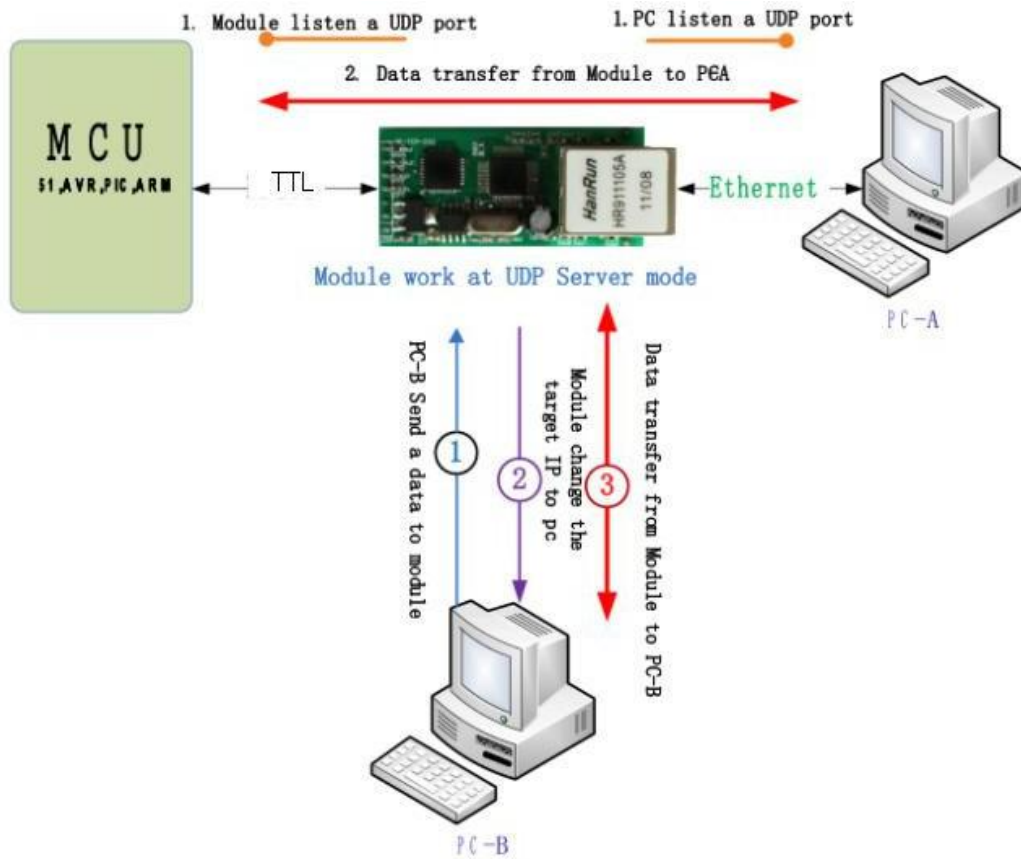
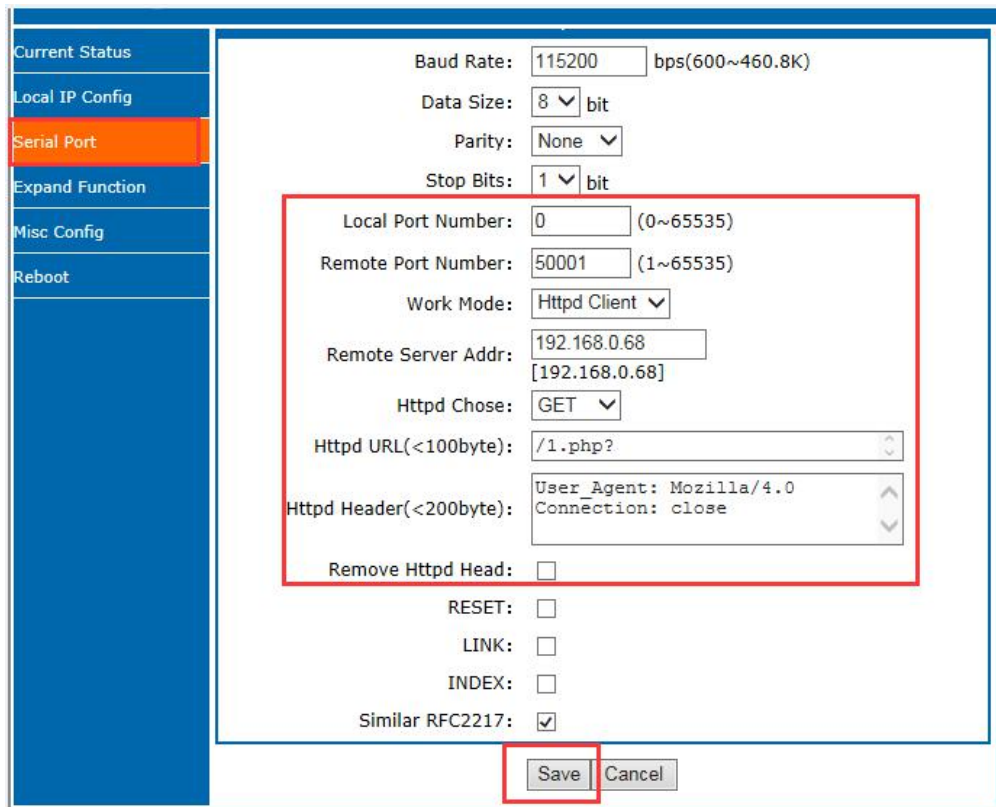

Diagram 4.2.4-2 UDP Server Model

4.2.5. Httpd Client

In this mode , users' terminal device can send required data to assigned HTTPD server via USR-TCP232-T2, and when TCP232-T2 receives the data from HTTP server, analyzes the data and sends the result back to the serial port.

No need for paying attention to the process of data conversion between the serial data and net data package. Simple parameter setting can realize the requirement serial device sent to HTTP server.



The screenshot shows the 'Serial Port' configuration page. The left sidebar has a menu with 'Serial Port' highlighted. The main area contains the following configuration options:

- Baud Rate: 115200 bps(600~460.8K)
- Data Size: 8 bit
- Parity: None
- Stop Bits: 1 bit
- Local Port Number: 0 (0~65535)
- Remote Port Number: 50001 (1~65535)
- Work Mode: Httpd Client
- Remote Server Addr: 192.168.0.68 [192.168.0.68]
- Httpd Chose: GET
- Httpd URL(<100byte): /1.php?
- Httpd Header(<200byte): User_Agent: Mozilla/4.0, Connection: close
- Remove Httpd Head:
- RESET:
- LINK:
- INDEX:
- Similar RFC2217:

At the bottom, there are 'Save' and 'Cancel' buttons.

Diagram 4.2.5-1HTTPD client Webpage

- 1.Setting USR-Tcp232-T2 as Httpd Client mode via webpage, and setting corresponded remote port and remote IP.
- 2.Configure HTTPD request method (Httpd chose such as Get or Post), Httpd URL(request packet URL) and Httpd header (packet header information) by webpage
- 3.The return data whether drop the package header can be set by webpage: **remove HTTPD head**
- 4.Click save, then restart the module to work.
- 5.Open serial port to send data, then the data of the serial port will submit to your webpage, meanwhile the serial port will receive the reply.
6. Please refer to the following diagram on sending requests

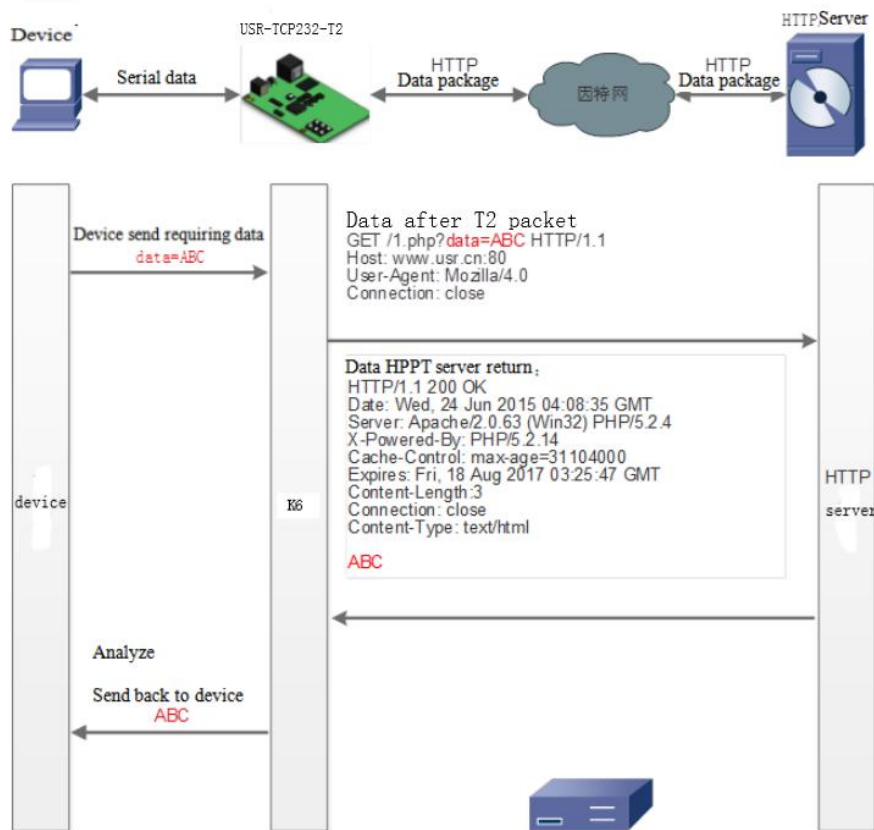

Diagram 4.2.5-1 HTTP client

4.2.6. TCP and UDP mechanism

	TCP	UDP
Advantages	Stable; Not easy to lose data package; Reliable connection mechanism;	Transmission interval is accurate; No connection mechanism; Easy and flexible;
Disadvantage	Easy to block up Information; Because of check and resend mechanism, interval isn't accurate	Under bad network condition, it is high risky to losing data package

4.3. DHCP and DNS Function

DHCP: Dynamic Host Configuration Protocol

When T2 connects to remote server, it can obtain an IP address automatically which router or gateway distributed. If you don't know how to set IP address or it can't connect because of the set IP is not in the same segment, the function is helpful for you.

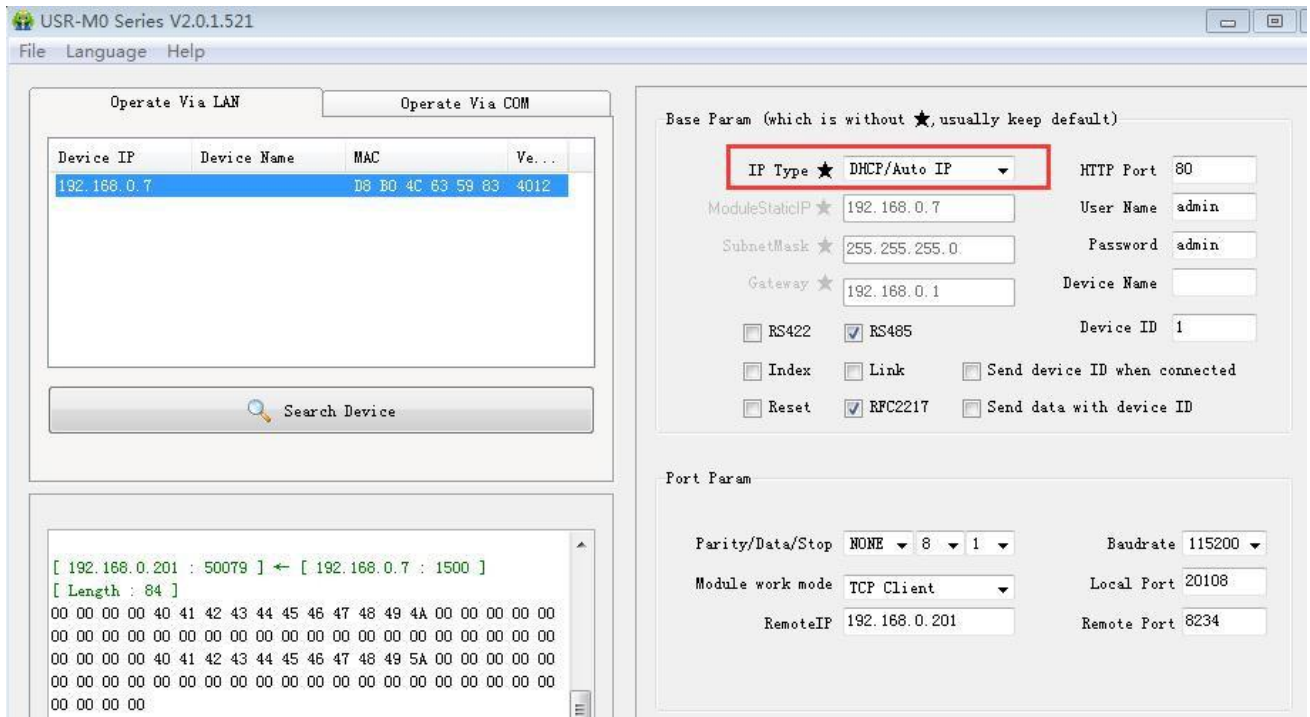

Diagram 4.3-1 DHCP

DNS: Domain Name System

e.g. domain name sever is cloud usr.cn, when we don't know Server IP or Server IP changed, this function plays an important role.

Note: when use NDS function, T2 gateway must be same as router IP or choose DHCP function.

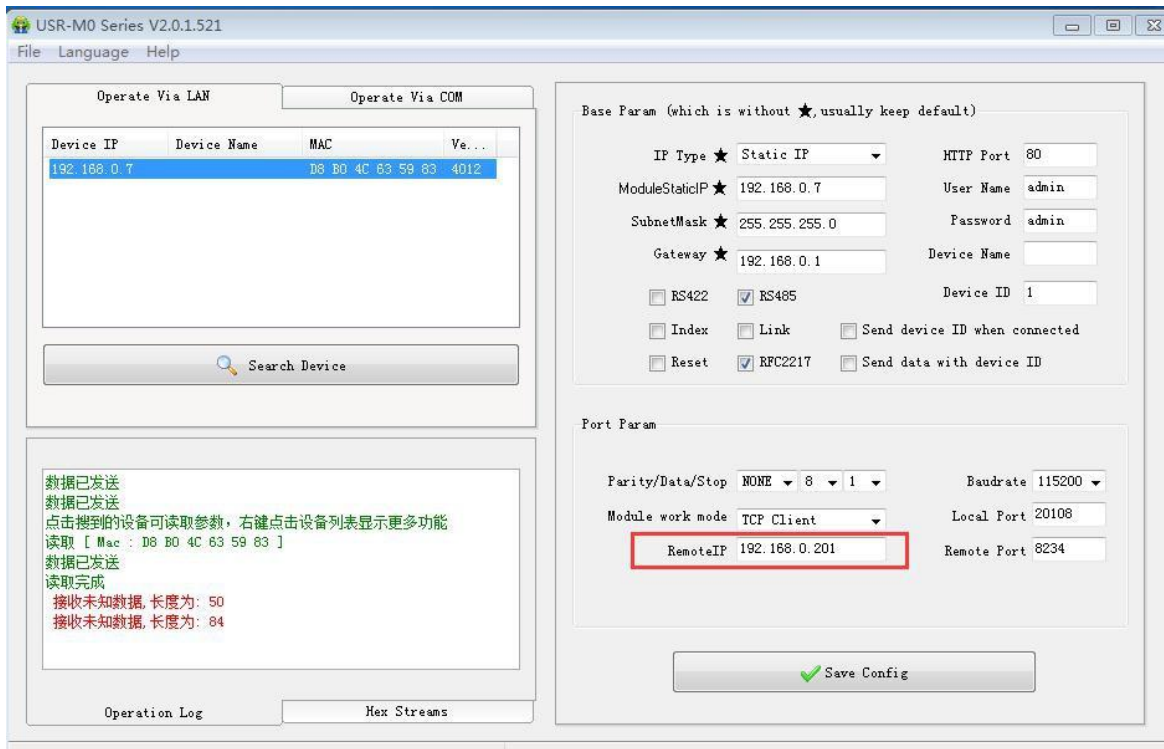

Diagram 4.3-2 DNS

4.4. VCOM

USR-VCOM Download: <http://www.usriot.com/usr-vcom-setup-software-v3-7-1-520/>

USR-VCOM Manual: <http://www.usriot.com/usr-vcom-setup-software-user-manual-v3-5-2/>

If user's upper computer and device are all connect by serial port, user can create a COM which has TCP/ IP to realize remote control by USR-VCOM software.

- 1) Turn off firewall and anti-virus software.
- 2) Install USR-VCOM.

I advise user to choose "Search" or "Smart vcom" to create virtual port. **Please refer to 4.4.3**

4.4.1. Module Work as Client

- 1) Set module parameters. T2 work model: TCP Client.
- 2) Open USR-VCOM, set virtual port as follows :

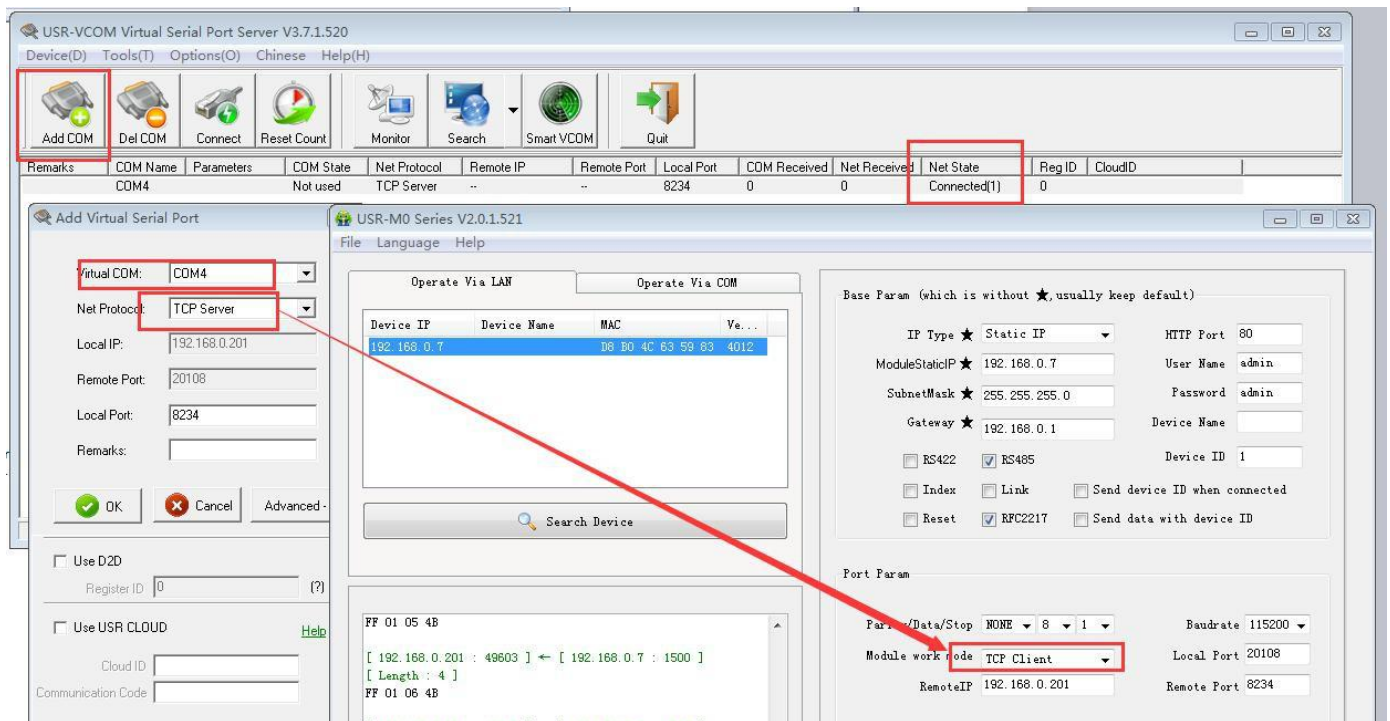

Diagram 4.4.1-1 Create Server Virtual Port

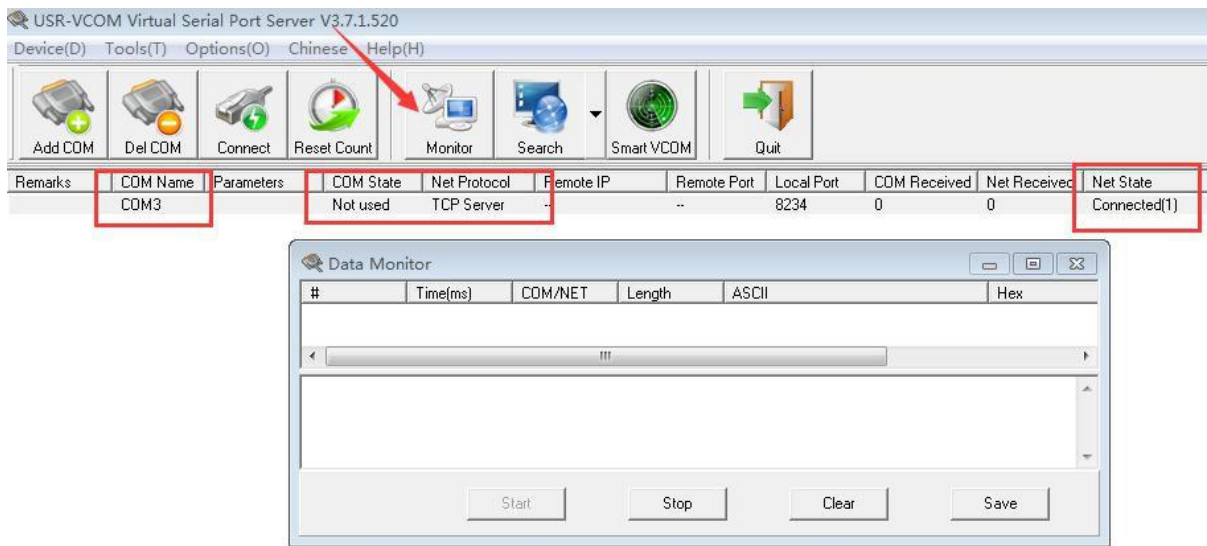

Diagram 4.4.1-2 Monitor Date

4.4.2. Module Work as Server

- 1) Set T2 work model: TCP Server.
- 2) Set virtual port as follows:

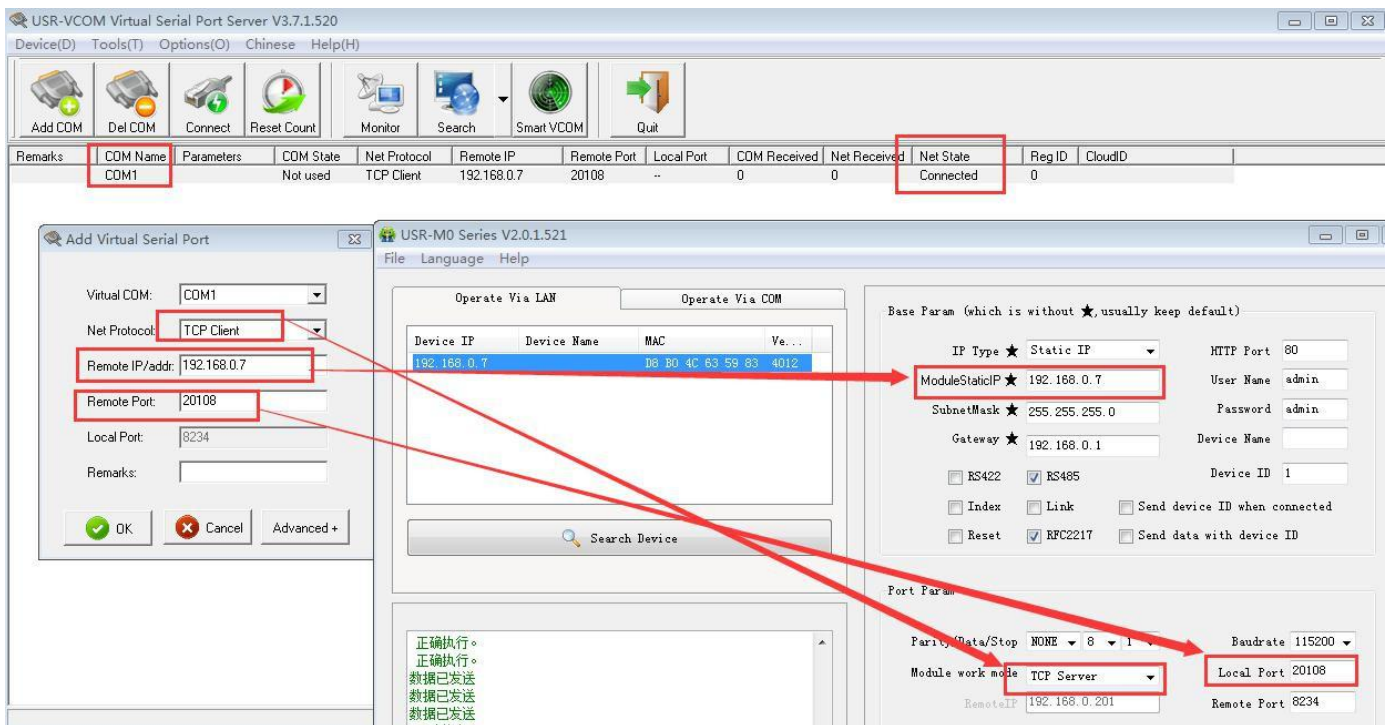

Diagram 4.4.2-1 Create Client Virtual Port

4.4.3. Create VCOM

1) Create VCOM by “search” button.

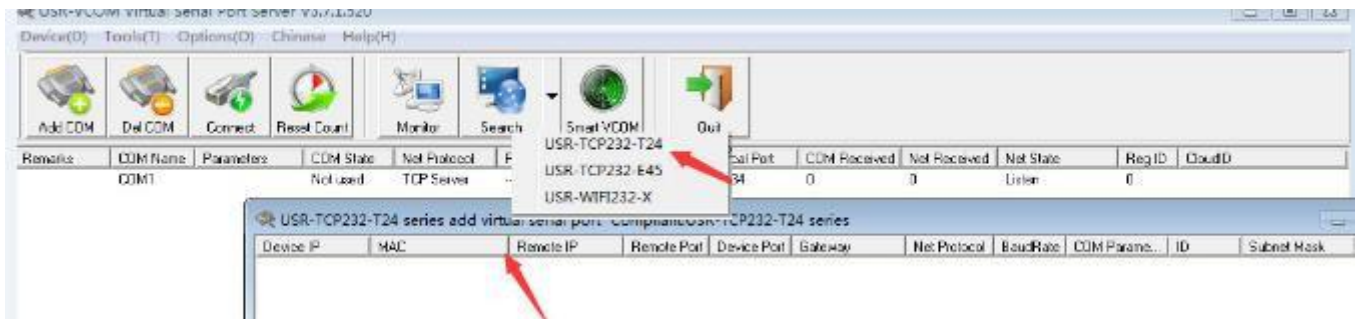

Diagram 4.4.3-1 Search Function

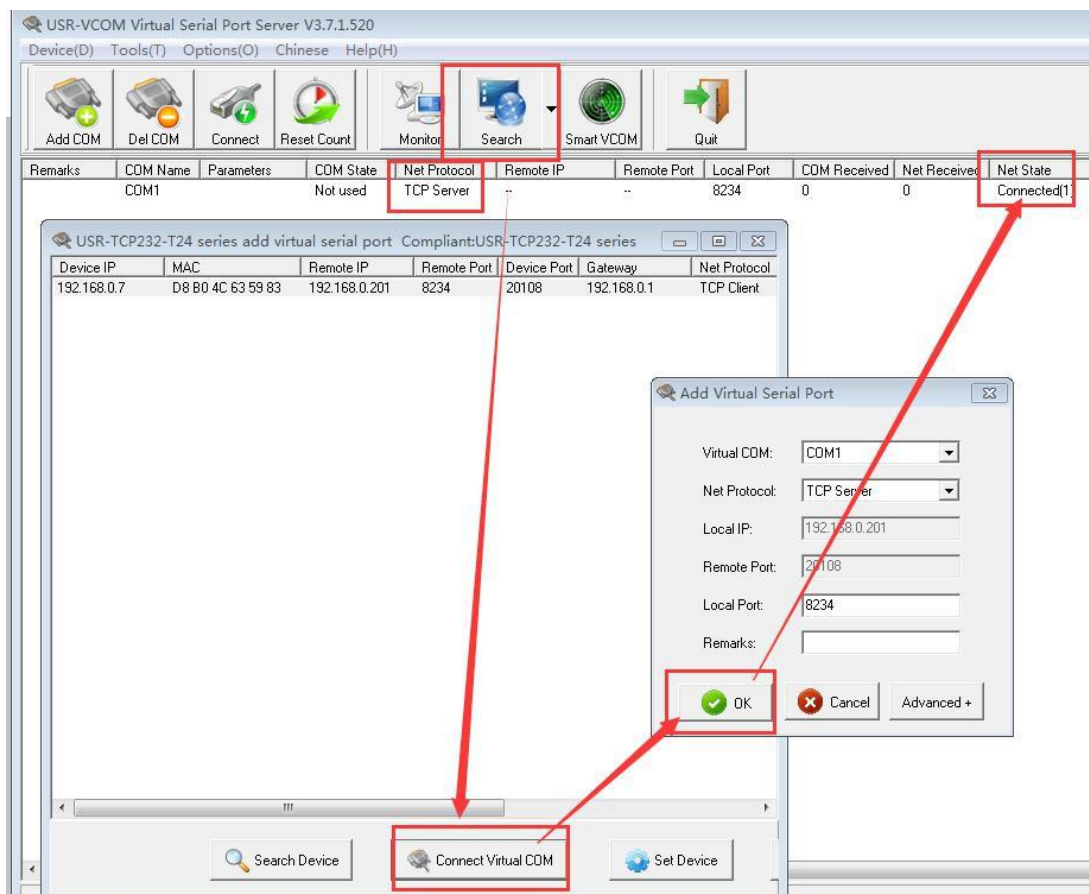

Diagram 4.4.3-2 Search Function

2) Automatically Create

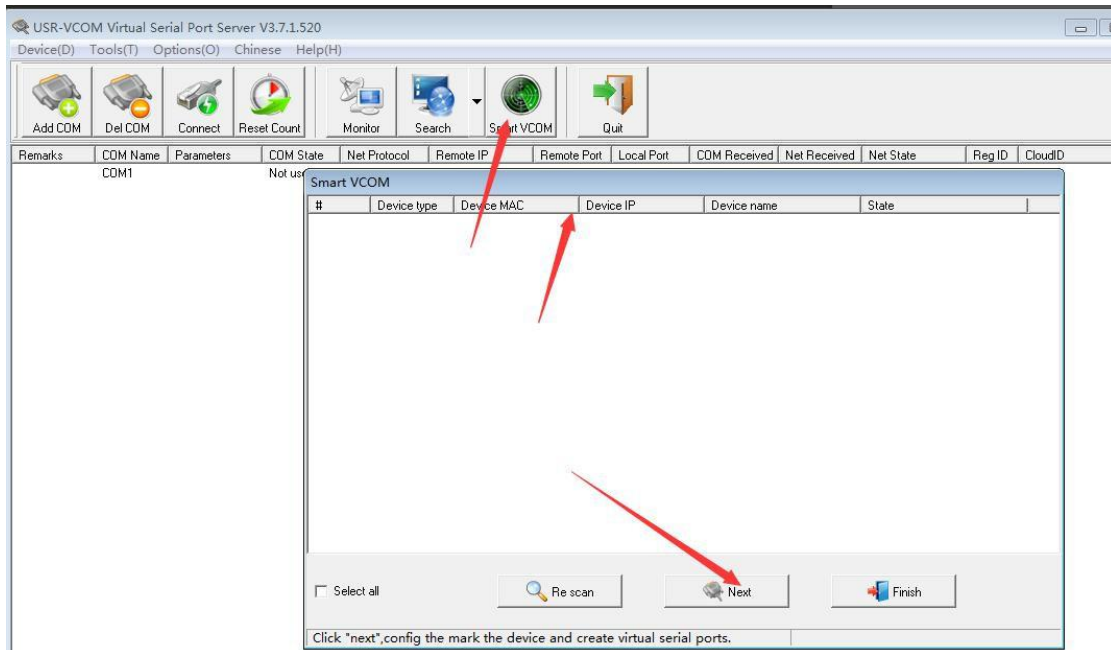

Diagram 4.4.3-3 Smart VCOM

4.5. Serial port function

4.5.1. Basic parameters

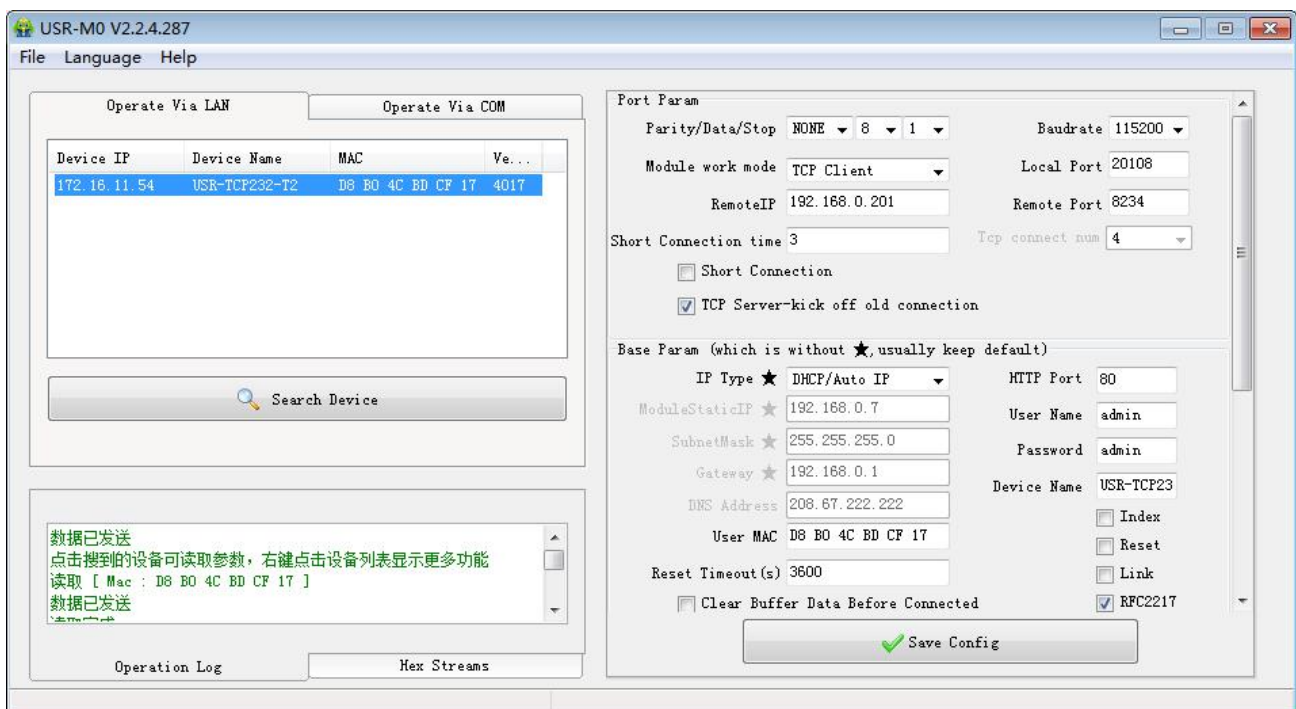

Diagram 4.5.1-1 software setting

Serial port basic parameters including: baud rate; data bits; stop bits; parity.

1. Baud rate: communicating speed of serial port, can be set from 600~460.8Kbps, support random baud rate.
2. Data bits:the range of it from 5 to 8.
3. Stop bits:can set from 1 to 2.
4. Parity: support none, odd, even, mark and space

4.5.2. Serial port framing

Since the data on the network is transmitted in the unit of data frames, it is necessary to send the frame data via serial port to the network, so as to transmit data more efficiently and quickly.T2 packages serial port data according to fixed packaging length and packaging time during data transmission.The default T2 packaging time is 4 bytes of packaging time and 400 bytes of packaging length.

The frame mechanism of serial port is based on the packaging time and the packaging length.

Serial port packaging time: the default is 4 bytes of send time.

Serial port package length: default package length is 400 bytes

4.5.3. RFC2217

This function is used to change USR-TCP232-T2 serial port parameter through network. E.g: change baud rate from 115200bps to 9600bps. It can be set by software or webpage.

By default ,it is in open state.

When using VCOM software, this function also works, the baud rate of software in PC will match Autonomic with the baud rate of USR-TCP232-T2, don't need to focus on serial port baud rate.

After restart, it is default parameter.

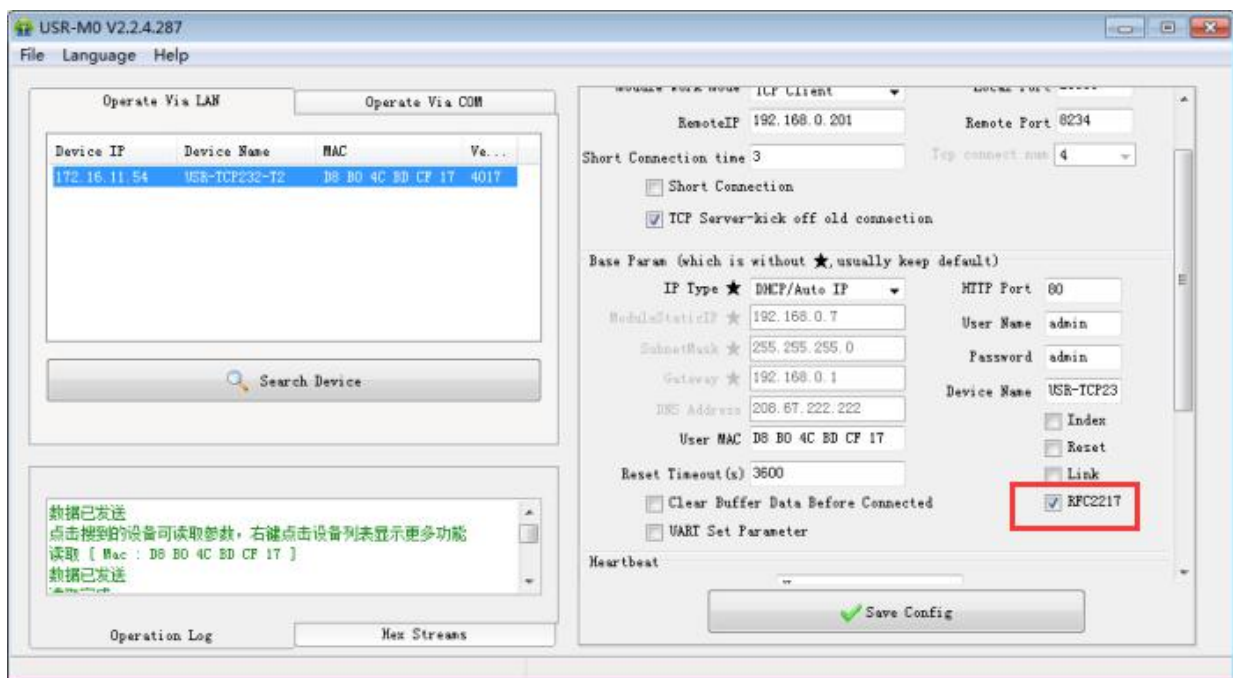

Diagram 4.5.3-1 RFC2217

4.6. Special function

4.6.1. Heartbeat package

In the transparent transport mode, user can choose T2 to send heartbeat package. Heartbeat package can be sent to net server, also can send to serial port, but can not send in the same time.

Sending to the net aimed at connecting with server, effect only in TCP client and UDP client.

In the application of the server sending fixed query command to device, to reduce the communication flow. The user can choose using the serial port to send the heartbeat package instead of the heartbeat from server.

The content of heartbeat package can be defined. The longest content is 40 bite. Time set from 1s to 255s.

It can ensure connection is reliable, put an end to connect feign death.

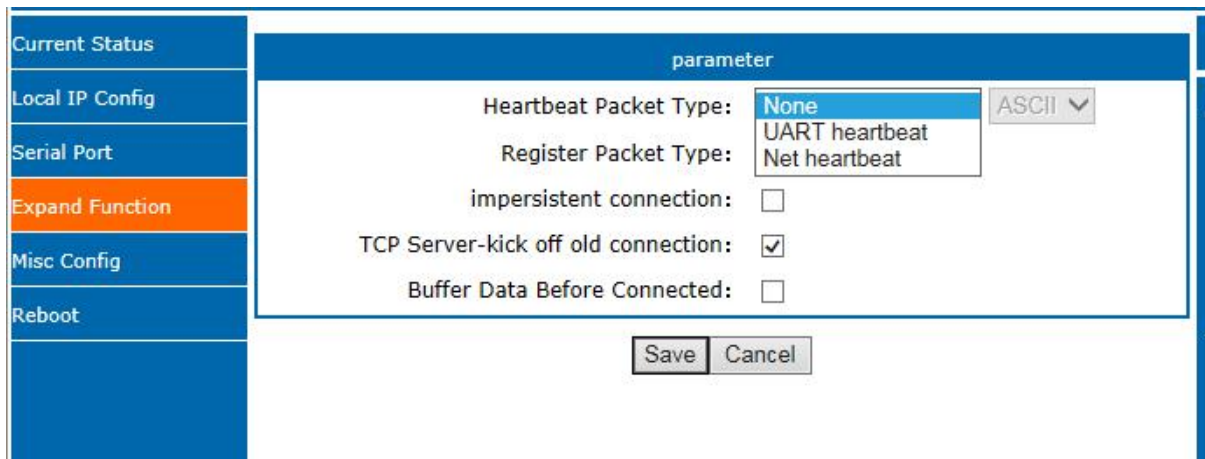

Diagram 4.6.1-1 heartbeat package

4.6.2. Registration package

In the transparent transport mode, user can choose T2 to send registration package. Registration package is used to identify data sources or do as the code to get the server authorization.

Registration package can be sent when the T2 built connection with server, also can installed in the head of the data package, as a data package. Registration package data can be MAC address or customize registration package data, where the custom registry setting content is up to 40 bytes.

The connection setting and sending registration package is mainly used to connect the server that needs to be registered. By default, this function is not checked.

Data carries the registration package: sending data in the front of the data access to the registration package, mainly for protocol transmission application.

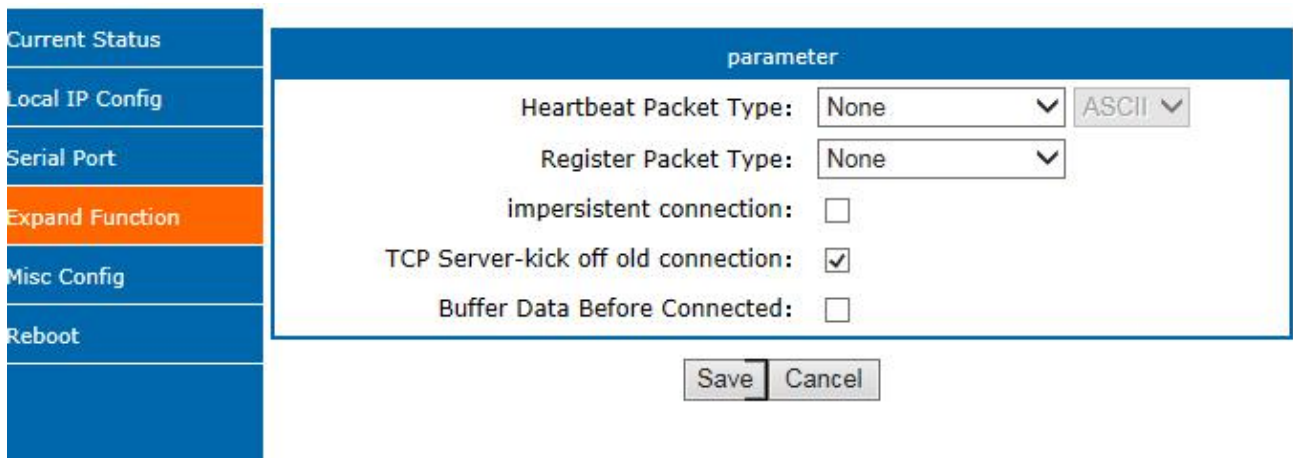

Diagram 4.6.2-1 registration package

4.6.3. USR-cloud



Diagram 4.4.3-1 USR-cloud

USR-Cloud software is a platform for communication between devices and PC software. The cloud software is mainly used for data transmission or monitoring remotely. This function only works in TCP client mode.

- ✓ Login link of USRIOT Cloud: <http://console.usriot.com>
- ✓ Remote server address: console.usriot.com
- ✓ Local port: The port of device, Remote port: Cloud software's port
- ✓ Device ID: It is assigned to device by cloud software
- ✓ Communications Code: Pass word generated after adding the device to cloud software

The following is test account of USR-Cloud:

Account: jin321_

Password: 1987322

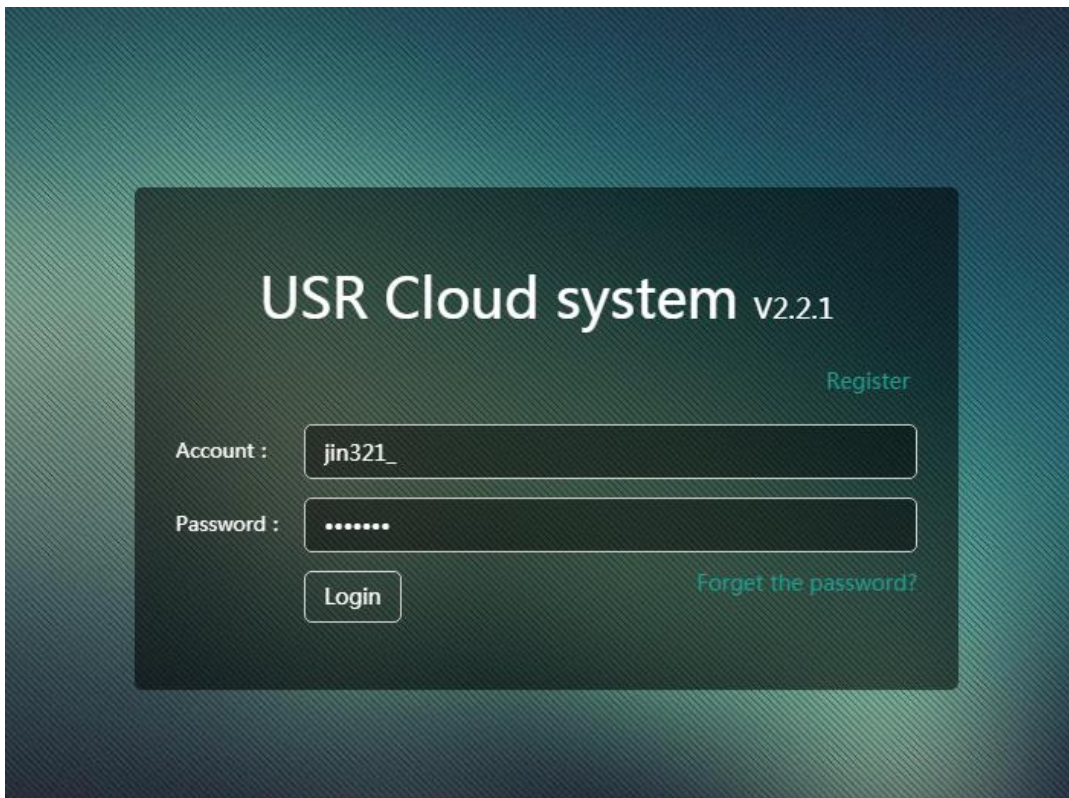

Also can be set in the webpage as fellows:

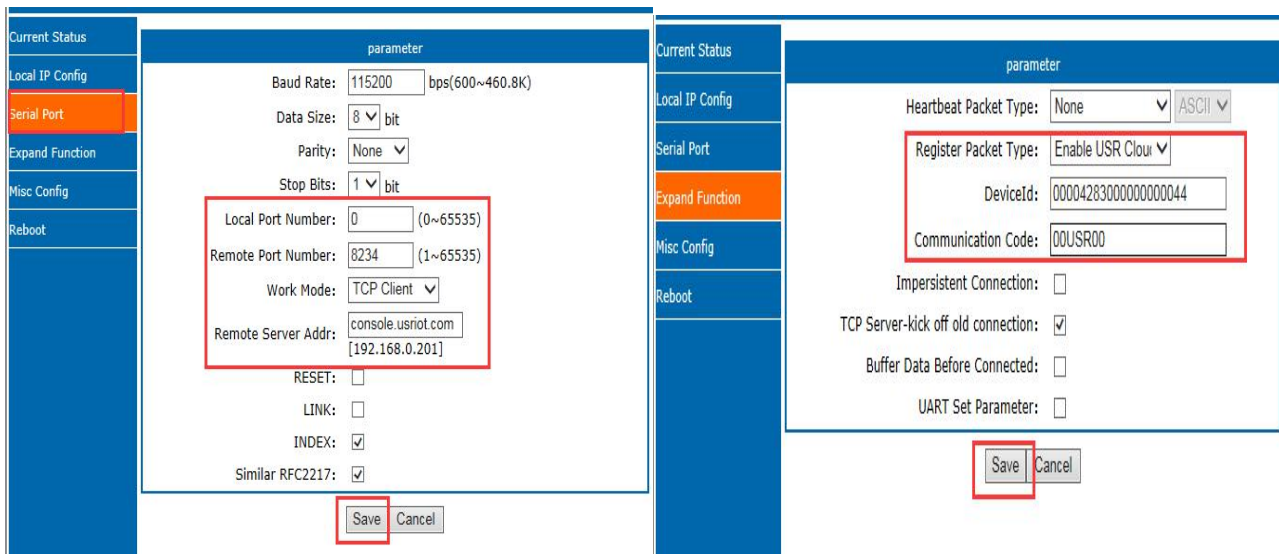

4.6.4. Customize webpage

T2 support customize webpage. The user can upgrade their webpage into T2 via customize webpage. To be more convenient for user, we have prepared upgrade webpage package in our website: <https://www.usriot.com/support/downloads/customized-webpage-usr-tcp232-t2-s2-customized-webpage-v4017.html> including webpage code, webpage tools can be download.



Diagram 4.6.4-1 webpage package

Upgrade webpage need to note that, destination IP set to be the IP address of T2, the final name of file is "fs",product choose the "M0", then click the upgrade.

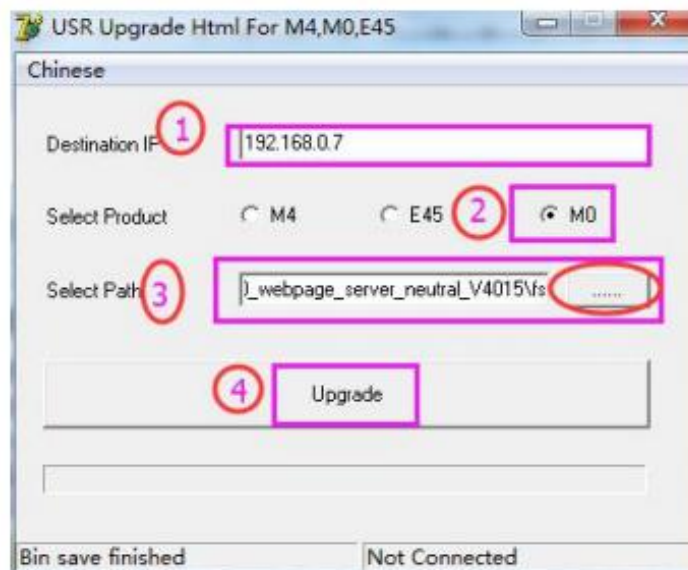

Diagram 4.6.4-2 upgrade

4.6.5. Link

Link pin is the status indicator pin for T2 to built communication. Link pin can be used as indication pin for TCP connection status.

When connected, it output low level; When unconnected, high level.

When T2 is under TCP model, Link pin will pull down. otherwise, it stays in high level.

When T2 is under DUP model, Link pin will always pull down. By default, it is not checked.

4.6.6. Reset

Reset used when the T2 fly or crash and can not built the normal connection,so can not work. Reset to initialize the module to resume normal operation.

When T2 works as TCP Client, T2 connects to TCP Server actively. When start Reset function, T2 try to connect to TCP Server for 30 times. If failed, T2 will restart automatically. By default, it won't be chose.

4.6.7. Index

Index is to resolve the problem that in TCP server mode, T2 can not divide the data sources or send data to special client when user have more than 2 client to connect the T2.

At most there can be 16 links when the T2 in the TCP server mode. The max number can set from 1to 16 as you want. Here we take the default number is 16 as example. Server send data to 16 clients, or the server receive the data from 16 clients, open the Index, mark to divide the different clients and user can recognize the data sources according to the mark, meanwhile send different data to special clients.

Index function can be set by software or web-page.

4.6.8. The number of the connected client

Then the USR-TCP232-T2 work in the TCP server mode, the max number of client to connect is 16, default is 4,the max number can be configuring as you want, which is be convenient for use. When the the number connecting clients more than 4, we should control the total data flow in 2.5KB/s if we need to send and receive meanwhile(not more than 200 bite/s).

If the number is 16 now, default use the new link instead of the older one, also you can set to use the older one. The webpage are as fellow.

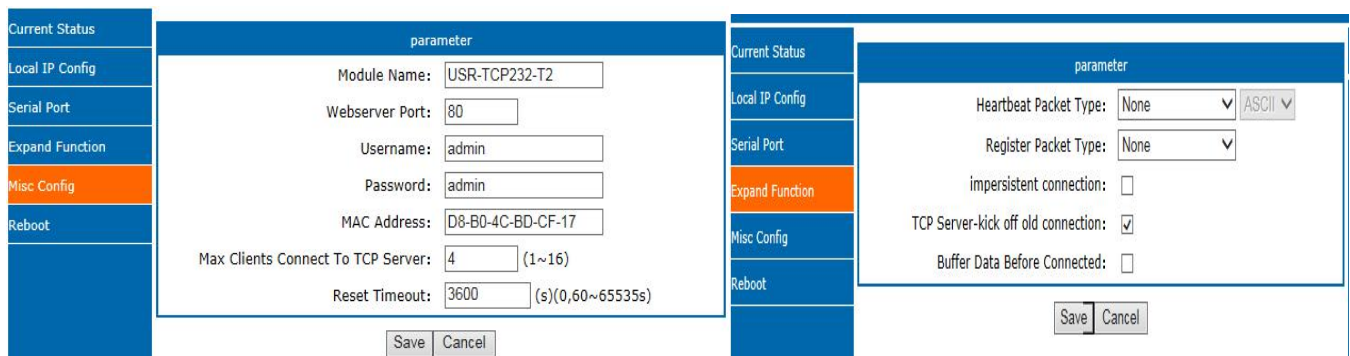

Current Status	parameter	Current Status	parameter
Local IP Config	Module Name: USR-TCP232-T2	Local IP Config	Heartbeat Packet Type: None
Serial Port	Webservice Port: 80	Serial Port	Register Packet Type: None
Expand Function	Username: admin	Expand Function	impersistent connection: <input type="checkbox"/>
Misc Config	Password: admin	Misc Config	TCP Server-kick off old connection: <input checked="" type="checkbox"/>
Reboot	MAC Address: D8-B0-4C-BD-CF-17	Reboot	Buffer Data Before Connected: <input type="checkbox"/>
	Max Clients Connect To TCP Server: 4 (1~16)		
	Reset Timeout: 3600 (s)(0,60~65535s)		
	Save Cancel		Save Cancel

Diagram 4.6.8-1 max client connect to TCP server

4.6.9. State

In the webpage of the USR-TCP232-T2, there is the state config page, which can show the current IP and the each connection sends data and the number of bytes of connection data, along with the total number of bytes sent and received by the T2 server on the page.

Now, under the TCP client mode, T2 can statistic the former 5 IP of devices and the number of the sent and received data. Refresh every ten seconds automatically. Under the TCP server mode, the T2 only static the number of the sent and received data, no connected IP.

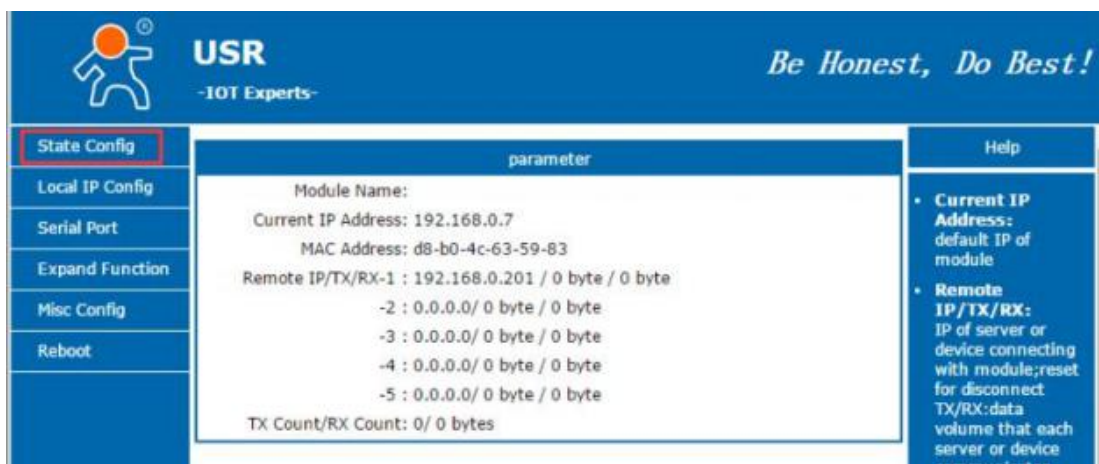

Diagram 4.6.9-1 State Configuration

4.6.10. Short connection

The aim to use this function is to save the resource of the server, usually used in the points to one point. Using the short connection can sure the current connection is the useful one, no extra control tools to screening.

TCP short connection can used in the TCP client, open it and send message. The connection will be broken automatically.

This function default to be off, the interval of disconnect can be configured after this function is open, the range from 2 to 255s, default is 3s, the diagram is as follow:

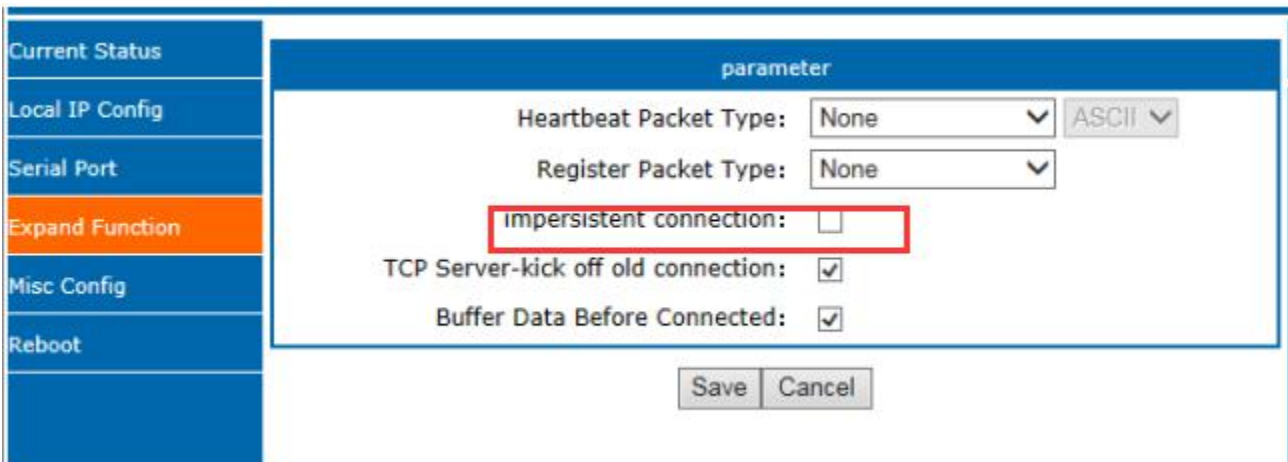

Diagram 4.6.10-1 impersistent connection Configuration

4.6.11. Clear buffer data

If the TCP have not built, the data that serial received will be placed in the cache, and the T2 serial port can receive 2Kbyte, after the TCP built, you can select is clear the cached data.

The default is not. Under the Httpd client mode or the TCP client mode, open the short connection and this function has no power.

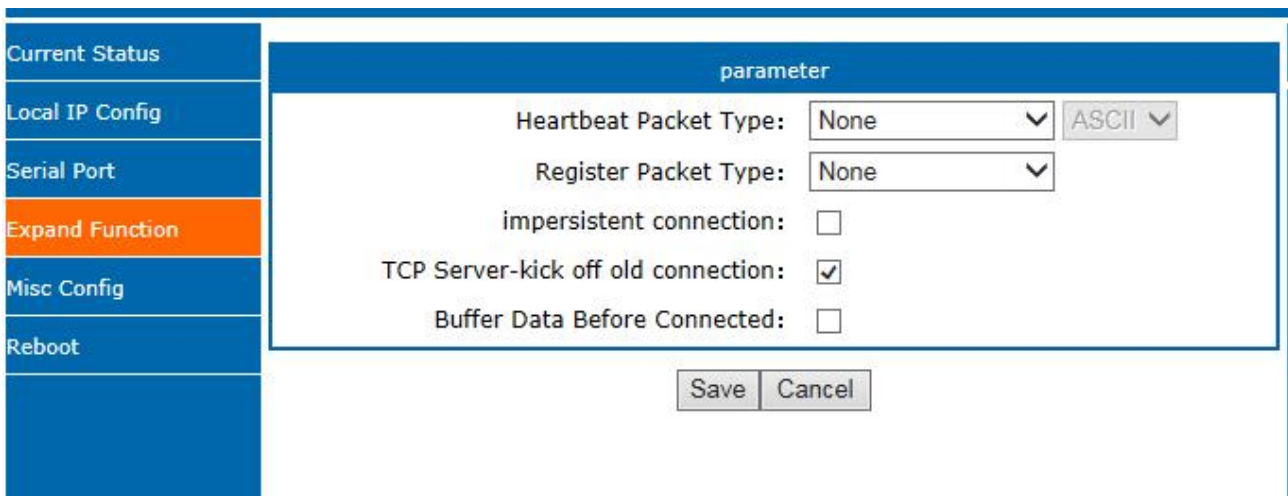

Diagram 4.6.11-1 clear buffer data Configuration

4.6.12. Restore out time

Restore out time is to make sure the long and stable work of T2, when the net port or network can not receive data for long time, T2 will restore out the setting time to avoid abnormal conditions affect the connection. Time for restore can set in the webpage. The normal work time of this function set 60~65535s, default is 3600s. if setting time less than 60s, default to be 0 and turn off this function. The setting is as fellow:

Current Status	<table border="1" style="width: 100%; border-collapse: collapse;"> <thead> <tr style="background-color: #0056b3; color: white;"> <th colspan="2">parameter</th> </tr> </thead> <tbody> <tr> <td>Module Name:</td> <td><input type="text" value="USR-TCP232-T2"/></td> </tr> <tr> <td>Webserver Port:</td> <td><input type="text" value="80"/></td> </tr> <tr> <td>Username:</td> <td><input type="text" value="admin"/></td> </tr> <tr> <td>Password:</td> <td><input type="text" value="admin"/></td> </tr> <tr> <td>MAC Address:</td> <td><input type="text" value="D8-B0-4C-BD-CF-17"/></td> </tr> <tr> <td>Max Clients Connect To TCP Server:</td> <td><input type="text" value="4"/> (1~16)</td> </tr> <tr style="border: 2px solid red;"> <td>Reset Timeout:</td> <td><input style="border: 1px solid red;" type="text" value="3600"/> (s)(0,60~65535s)</td> </tr> <tr> <td colspan="2" style="text-align: center;"> <input type="button" value="Save"/> <input type="button" value="Cancel"/> </td> </tr> </tbody> </table>	parameter		Module Name:	<input type="text" value="USR-TCP232-T2"/>	Webserver Port:	<input type="text" value="80"/>	Username:	<input type="text" value="admin"/>	Password:	<input type="text" value="admin"/>	MAC Address:	<input type="text" value="D8-B0-4C-BD-CF-17"/>	Max Clients Connect To TCP Server:	<input type="text" value="4"/> (1~16)	Reset Timeout:	<input style="border: 1px solid red;" type="text" value="3600"/> (s)(0,60~65535s)	<input type="button" value="Save"/> <input type="button" value="Cancel"/>	
parameter																			
Module Name:		<input type="text" value="USR-TCP232-T2"/>																	
Webserver Port:		<input type="text" value="80"/>																	
Username:		<input type="text" value="admin"/>																	
Password:		<input type="text" value="admin"/>																	
MAC Address:		<input type="text" value="D8-B0-4C-BD-CF-17"/>																	
Max Clients Connect To TCP Server:	<input type="text" value="4"/> (1~16)																		
Reset Timeout:	<input style="border: 1px solid red;" type="text" value="3600"/> (s)(0,60~65535s)																		
<input type="button" value="Save"/> <input type="button" value="Cancel"/>																			
Local IP Config																			
Serial Port																			
Expand Function																			
Misc Config																			
Reboot																			

Diagram 4.6.12-1 reset timeout Configuration

5. Parameter setting

This character mainly to introduce how to setting the T2 parameters. Achieve their own personalized application through parameter settings

Including setting software setting parameter, webpage setting parameter and serial setting parameter.

User setting steps:

Modify the user name and password→ setting the access way to the IP address→ serial parameter→ the related parameter for work method.

To ensure the normal use of software, the following steps are necessary

1. When using setting software to setting parameter, T2 and the PC of the setting software are in a LAN.
2. Close the antivirus software and firewall software.
3. Close the irrelevant network card.

5.1. Network protocol setting parameter

5.1.1. Setting software setting parameter

Open the software and click search, searching all the T2 in the LAN. The information you need to search including current IP, device name, MAC address and the vision of T2.

(download: <https://www.usriot.com/support/downloads/usr-m0-setup-software-v224287.html>).

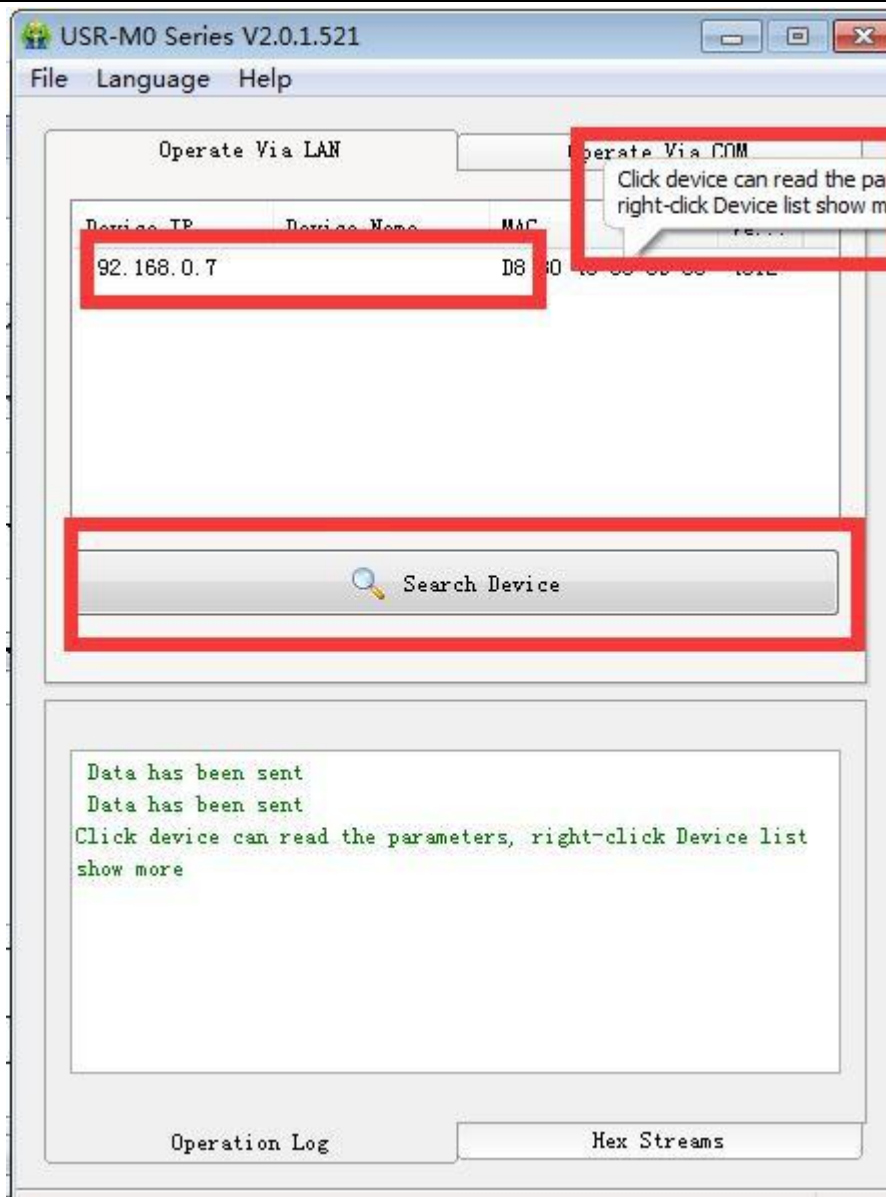

Diagram 5.1.1-1 Search

1. Click the searching content, check the password of the T2 at first, if the password is right, the information for T2 will be shown. If the password is wrong, the software will pop-up a window for username and password. Fill in the right one and click enter. The default name and password are admin), so if all thing are default, the setting software will not pop-out the widow of username and password.

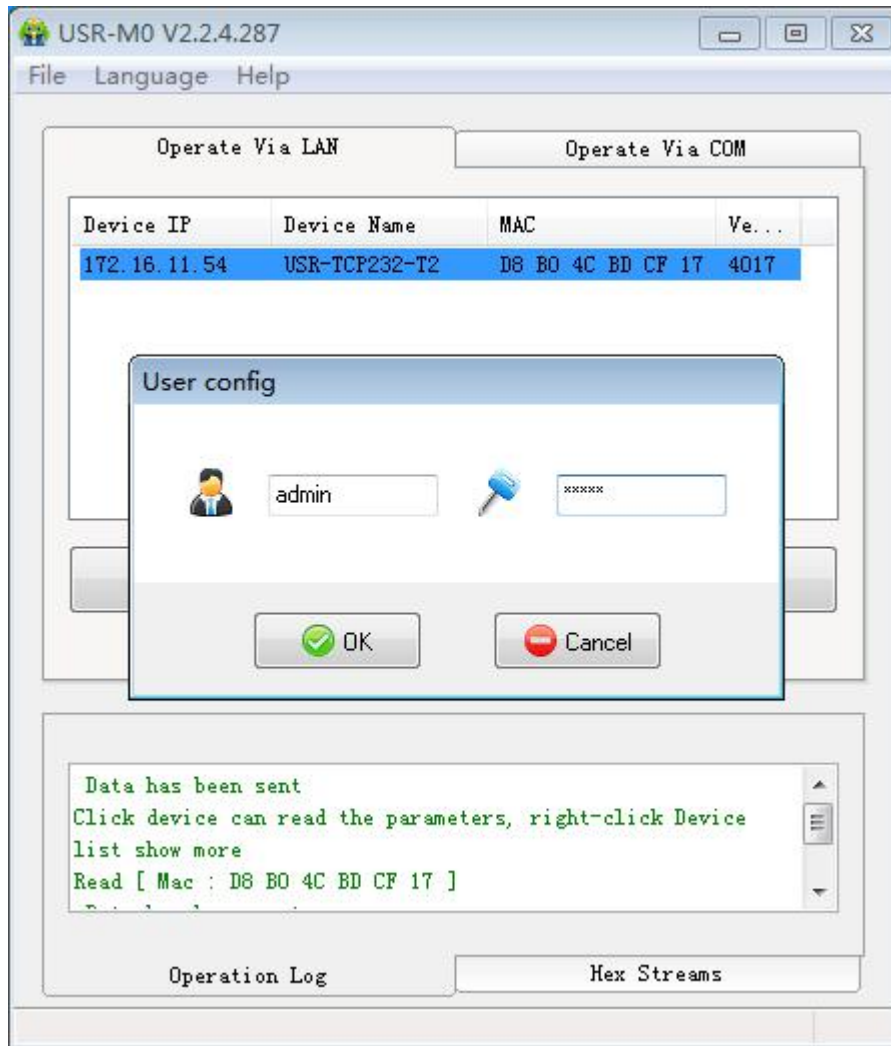

Diagram 5.1.1-2 Search

2. Basic parameter setting

Click the searching device and you can see the basic parameters needed to set, combined with the function introduction of the third chapter, setting the parameter you need, then click the save. All the parameters you need have been set successfully, others keep default, no modify.



Diagram 5.1.1-3 Basic parameters

- HTTP port: the port default is 80
- Username: the login username of T2, the authentication code for modify the parameter, can prevent other users modify the parameters of T2 in LAN.
- Password: the password of the T2, correspond with username.
- Device name: the T2 name can be customize.
- IP type: static IP and DHCP
- Module Static IP: the static IP of T2, please put it in the same LAN when setting it.
- Subnet masks: default is 255.255.255.0
- Gateway: usually is the router IP, after correct setting you can communicate across the LAN and do the domain name resolution.

3. Serial parameter

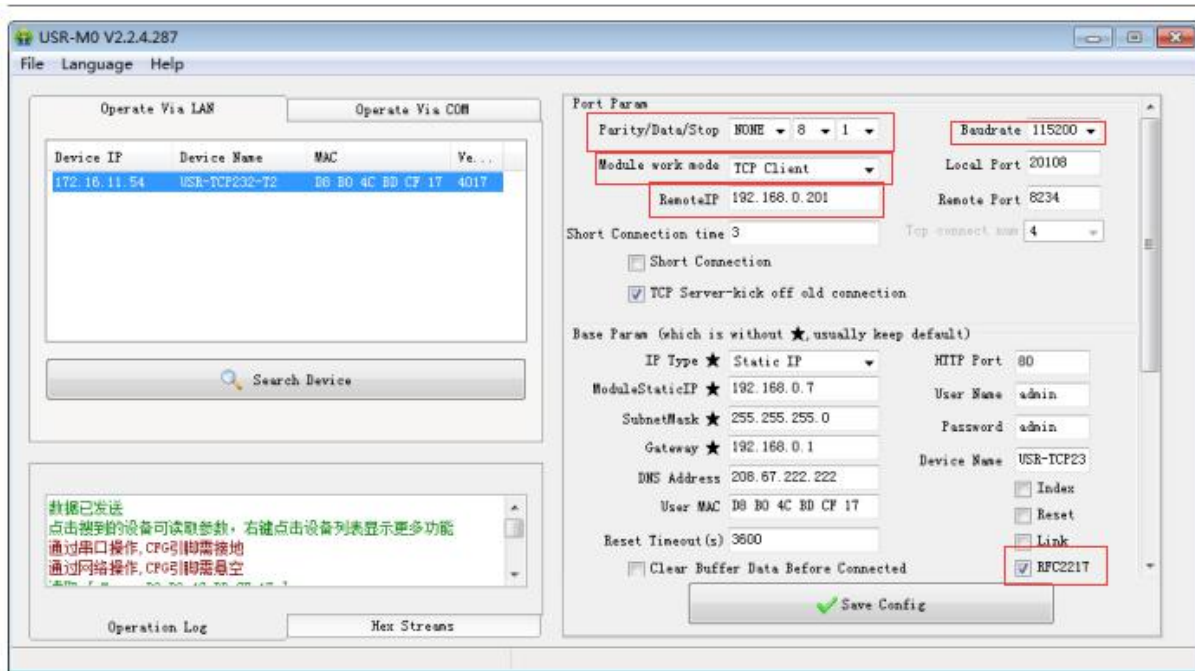

Diagram 5.1.1-4 Serial parameters

- Serial baud rate: the baud rate for serial port communication, both standard and customize baud rate are ok.
- Parity/data/stop: serial port parameters
- Work mode: TCP Server /TCP Client/Httpd Client/UDP Client/UDP Server
- Remote IP: when T2 works in TCP client, UDP client and HTTPD client mode as a client, the IP or domain name of the server that it connected.
- Similar RFC2217: used if need to change the serial port in transport. Use with V-COM or you can reference the software manual.

4. Check data

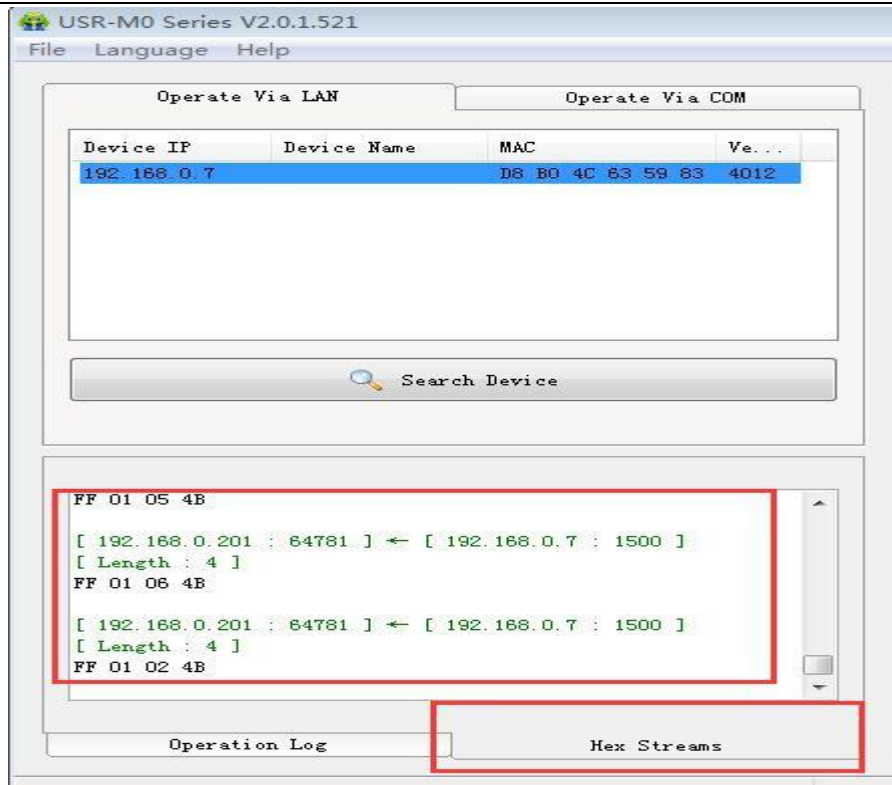

Diagram 5.1.1-5 Check Streams

5. Press CFG (Reload) and click “operate via COM”

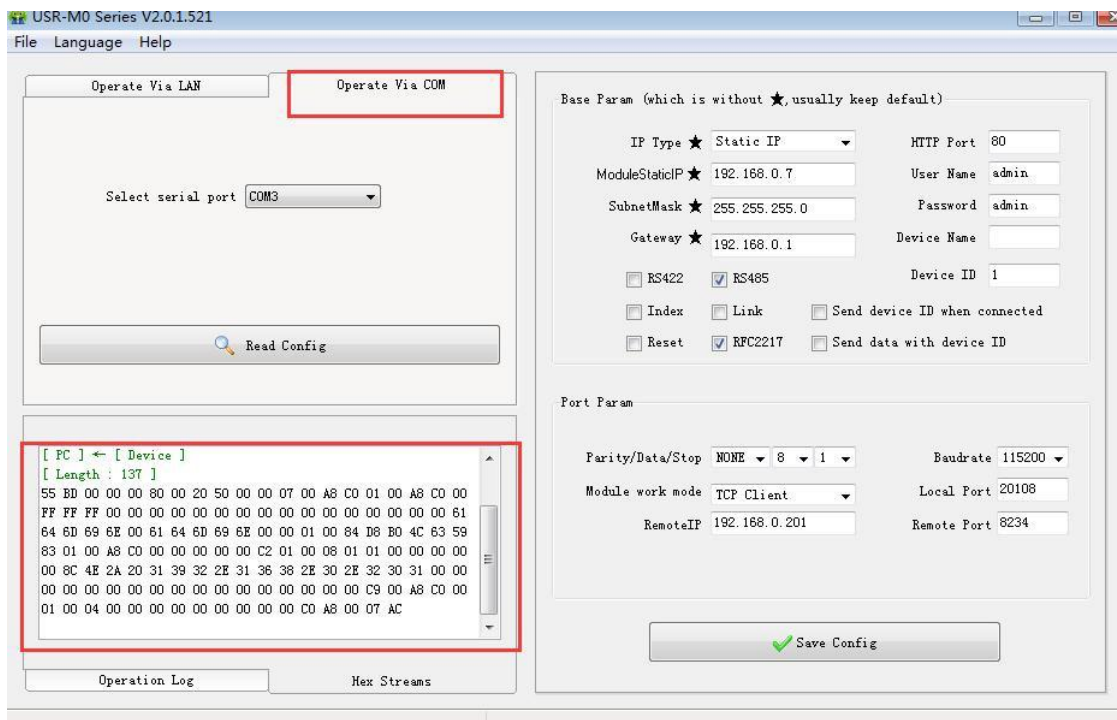

Diagram 5.1.1-6 Port setting

6. Firmware upgrade

If the module firmware need to upgrade to the high vision,user can consult with sales to get the upgraded firmware and click the device, upgrade the vision. When you upgrade it,connect directly the device and PC and notice that PC upgrading module is forbidden.

Select the device and right click, then upgrade the firmware.

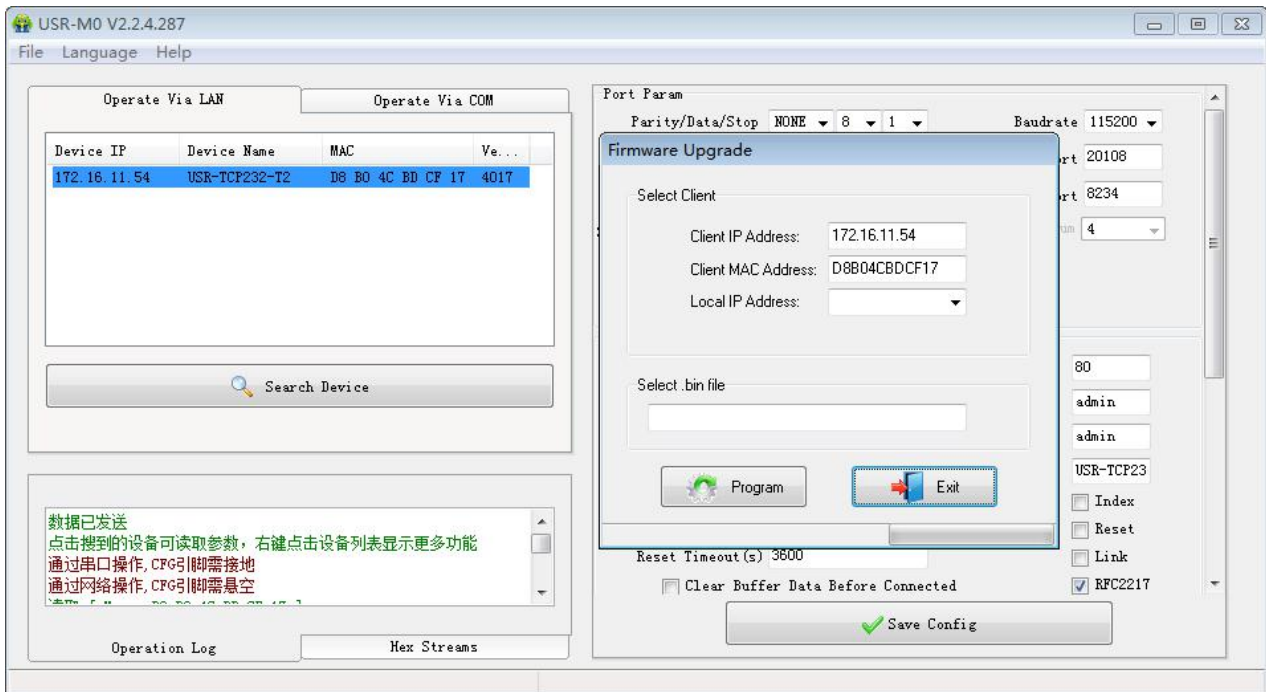

Diagram 5.1.1-5 Serial parameters

5.1.2. Protocol configuring to setting parameters

Achieve it: searching→ setting→ save→ restore using protocol, which is convenient for user to make their setting software, details you can find the “USR-TCP232-T2 software manual”.

5.2. Webpage setting parameters

Open the browser and enter the IP of T2, default is 192.168.0.7 or you can click right on the T2 and open web, filled the user name: admin and password: admin, then login and you can enter the login page.

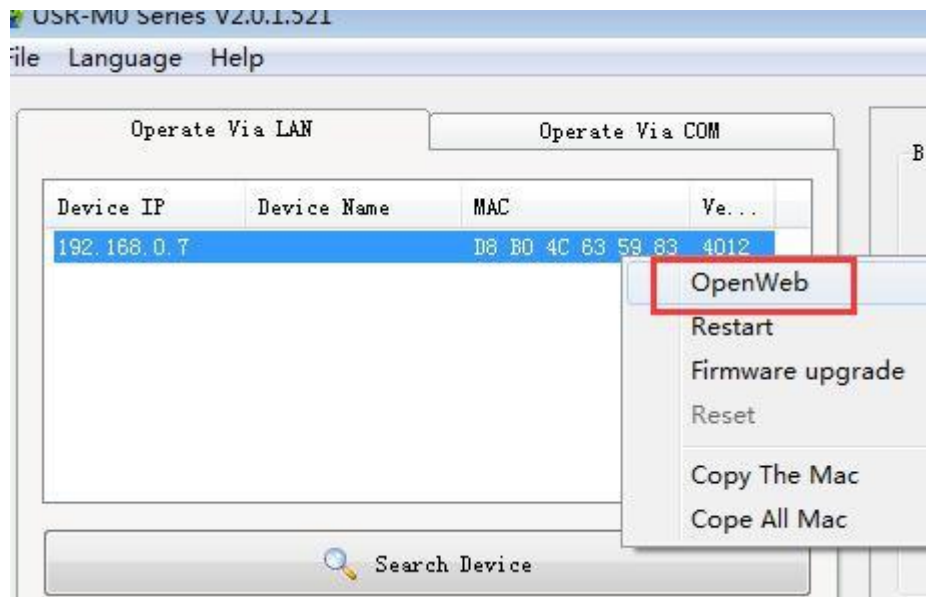

Diagram 5.2-1 Open Web

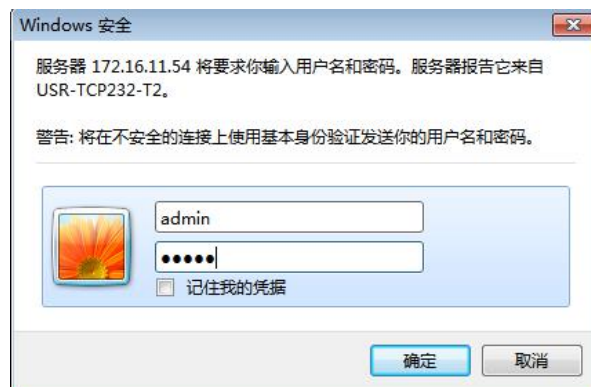

Diagram 5.2-2 Username and pass word

Click the English or Chinese on the right upper to switch the language.

5.2.1. State Configuration

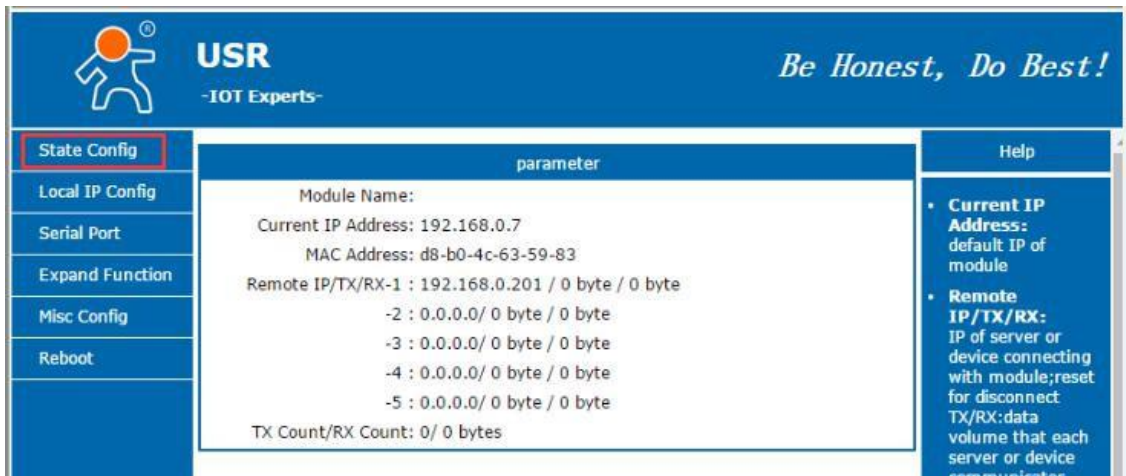

Diagram 5.2.1-1 State Configuration

This page show some information of the T2

- Module name: default is USR-TCP232-T2
- Current IP address: default is 192.168.0.7
- MAC address: the unique in the world
- Remote IP /TX/RX: the device has connected and the data number of receive and send. TX means send and RX means received
- TX count/RX count: Total number of connection send or received.

5.2.2. Local IP

Modify the parameters and save, then modify the parameter in next page. If the parameter need not to modify, click the restore and work.

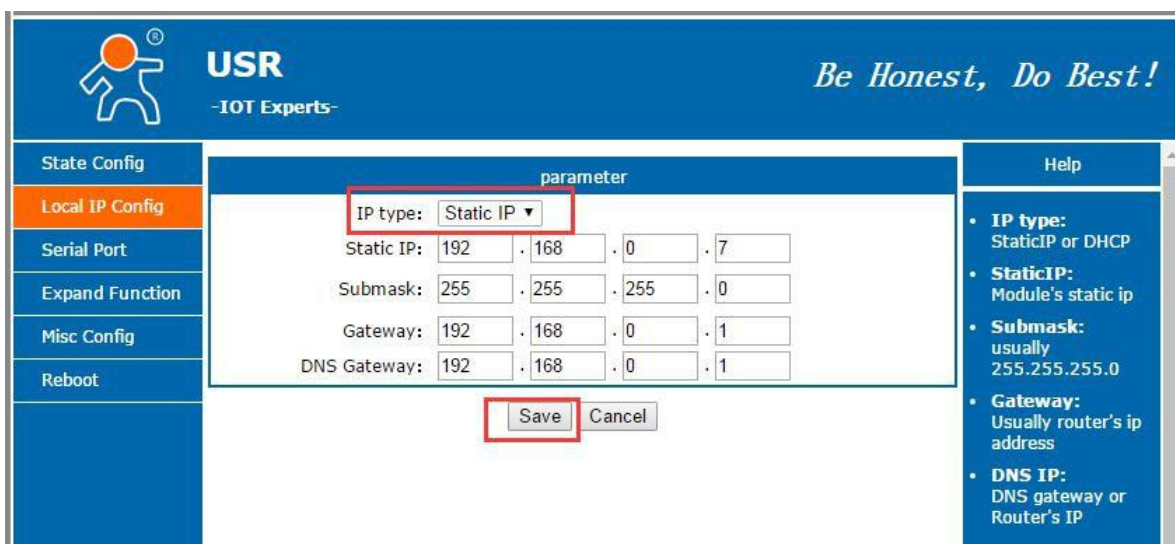

Diagram 5.2.2-1 Local IP



Diagram 5.2.2-2 Local IP

- IP type: including static IP and DHCP, default is static IP.
- Static IP: default is 192.168.0.7 and can be modify as you want
- Subnet masks: 255.255.255.0
- Gateway:
- DNS Gateway:DNS server

5.2.3. Serial port

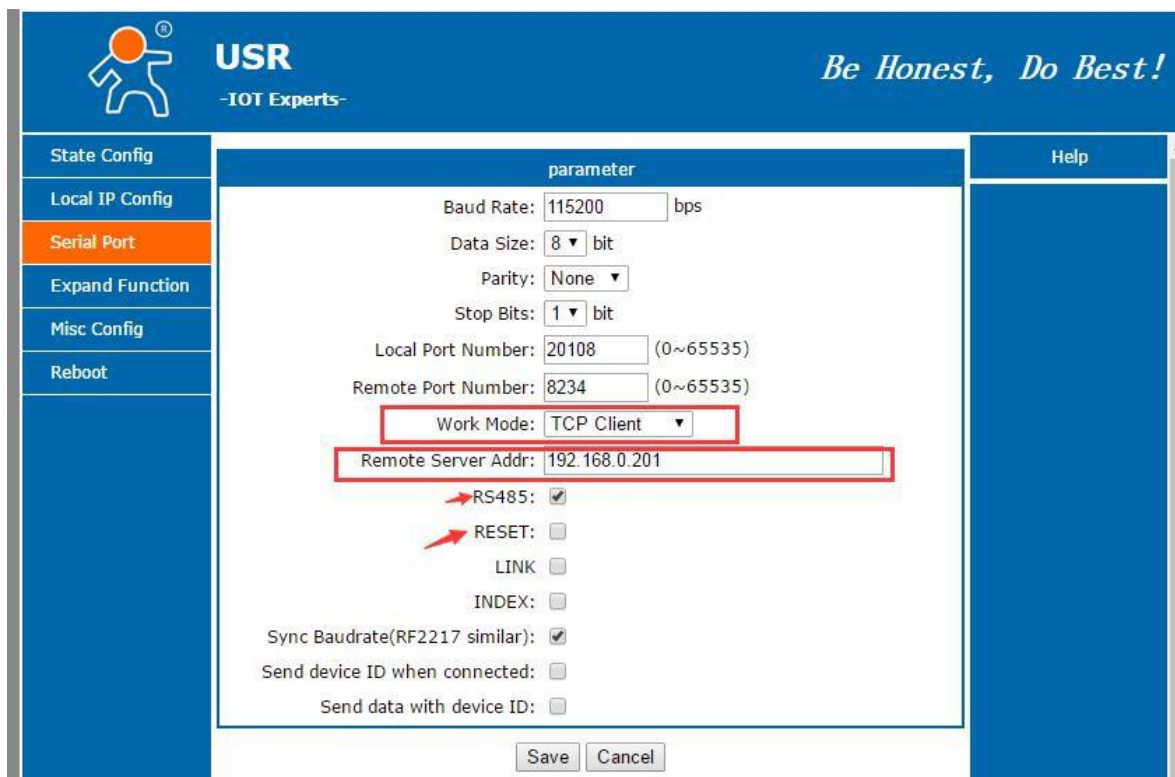

Diagram 5.2.3-1 Serial Port

- Baud rate: default is 115200 bps
- Data: default is 8 bit
- Parity: including: including None, Odd, Even, Mark and Space. Default none
- Stop bits
- Local port: can be change from 0 to 65535. Default is 20108
- Remote port: can be change from 0 to 65535.Default is 8234

- Work mode: default is TCP client
- Remote server address
- Special functions including RS485(no RS232 in T2) reset(introduce in above) link, index, RFC2217 similar, send device ID where connected and send data with device ID

5.2.4. Expand function

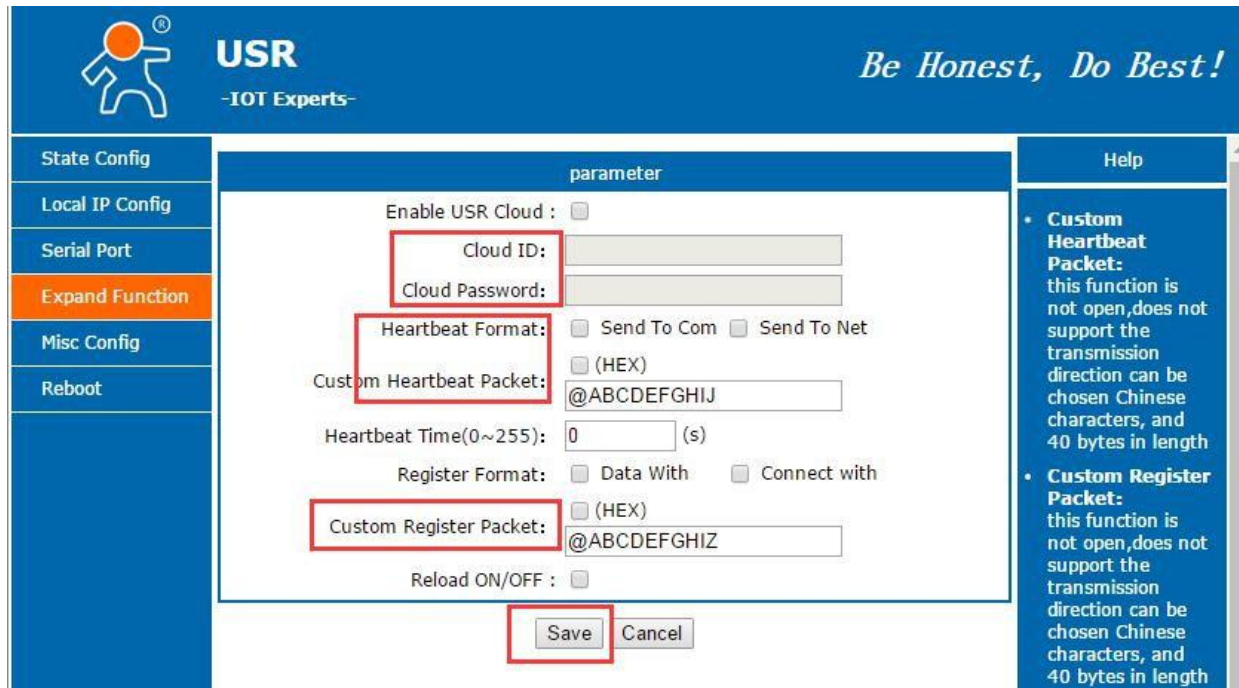

Diagram5.2.4-1 Expand function

- Customize heartbeat package: open with webpage, content customize and the max number is 40bite
- Customize registration package: open with webpage, content customize and the max number is 40bite, the method to use can be customize
- Short connection: enable under the TCP client and the time can be customize
- Clear buffer data: whether or not
- TCP server-kick off old connection
- Serial port parameter setting: open with webpage and setting with serial port parameter

5.2.5. Misc configuration

Diagram 5.2.5-1 Misc Setting

- Module name: default is USR-TCP232-T2 and can be modify here
- Webservice port number: default is 80
- Module ID: use for identify module
- USR-cloud number and password: default is admin
- MAC address: the unique one in the word
- Max clients connect to TCP server: can modify from 1 to 16.
- Reset timeout

5.2.6. Reboot

Diagram 5.2.6-1 Misc Setting

Save all the data and restore, then the T2 work

5.3. AT comment

5.3.1. AT command overview

AT+ command is the command collection that perform the command transport using UART and module under the order mode. Later we will interpret the type in detail.

Powered successfully, we can setting the module with UART.

The default UART port parameters of the module are: baud rate1152000, no parity, data 8 and stop 1.

Instr

AT command test tools. UART interface command to use secureCRT software tool or USR pro APP. Below are using the secureCRT with UART to perform.

From transparent transport to AT command need two step as below:

- Fill “+++”in the UART. After the module receive the “+++”,it will send a “a” to confirm;
- Fill the confirming “a” in the UART, after the module receive and send “+ok”, enter the AT command mode.

Instr: if no feedback after fill “+++”and “a”, as the above.

Fill “+++”and “a” need to achieve in the time to reduce the chance of entering command mode while working normally accidentally. Detail requirement are as fellows.

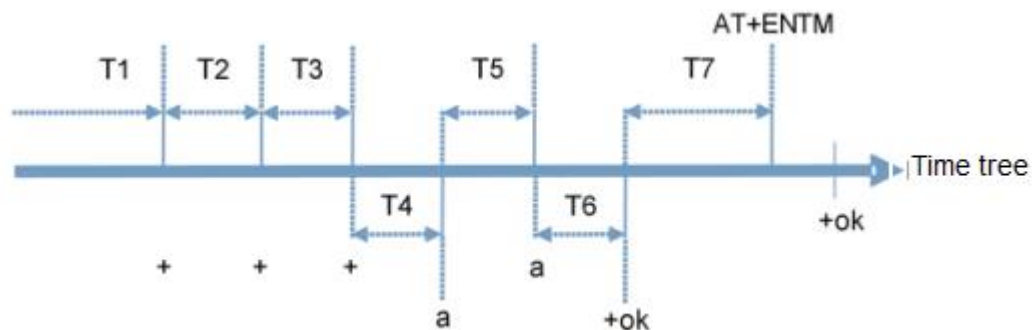

Diagram5.3.1-1 AT command time tree

Time requirement:

T1>the interval of serial port package

T2<300ms

T3<300ms

T5<3s

The order change into temporary command mode from transparent transport mode:

1. Serial mode device send “+++”to module continuously. The module receive and send “a” back. Before sending“+++”is the packaging time and can not send any data.
2. After receive “a” feedback a “a”in 3s.
3. After the module receive “a, send “ok”to the device, and enter “AT”command
4. After the device receive “+ok” and know the module enter the AT command mode, then send AT command.

The order change into transparent transport mode from AT command mode:

1. Serial device send "AT+ENTM" to module.
2. After the module receive the command, feedback "+ok", then back to the previous working mode.

5.3.2. AT command error code

Error code	Instr
-1	Invalid format
-2	Invalid order
-3	Invalid operator
-4	Invalid parameter
-5	Not allow

Form5.3.2-1 Error code

5.3.3. AT command

NO	command	Instr
1	E	Enable/disable the echo function
2	Z	Restore module
3	VER	Query the vision
4	ENTM	Exit AT command mode
5	RELD	Reset default settings
6	MAC	Query module MAC address
7	USERMAC	Setting customize MAC
8	WEBU	Setting/ query username and password
9	WANN	Setting/ query WAN port parameters
10	DNS	Setting/ query DNS server address
11	WEBPORT	Setting/ query webpage port
12	UART	Setting/ query serial parameters
13	SOCK	Setting/ query SOCK parameters
14	TCPSE	Setting/ query whether kick off order connection
15	SOCKLK	Query TCP connect status
16	SOCKPORT	Setting/ query local port number
17	RECEN	Setting/ query RFC2217 enable
18	PDTIME	Query the product time
Registration package function		
19	REGEN	Setting/ query registration package mechanism
20	REGTCP	Setting/ query registration package perform mechanism
21	REGCLOUD	Setting/ query USR-cloud username and password
22	REGUSR	Setting/ query the content of registration package that customized

Httpd client function		
23	HTPTP	Setting/ query in httpd client mode, the asking way of the http
24	HTPURL	Setting/ query the URL in httpd client mode
25	HTPHEAD	Setting/ query the package head in httpd client
26	HTPCHD	Setting/ query HTP remove the package head
Heartbeat package		
27	HEARTEN	Setting/ query heartbeat package enable
28	HEARTTP	Setting/ query method of the heartbeat package send
29	HEARTTM	Setting/ query the heartbeat package time
30	HEARTDT	Setting/ query customize heartbeat package
Expand function command		
31	SCSLINK	Setting/ query the indicating function of the status of socket connection
32	CLIENTRST	Setting/ query the TCP client mode reset function enable/disable
33	INDEXEN	Setting/ query index function
34	SOCKSL	Setting/ query short connection function
35	SHORTO	Setting/ query short connection time
36	UARTCLBUF	Setting/ query clear serial port cache before module build connection function enable/disable
37	RSTIM	Setting/ query timeout reset time
38	MAXSK	Setting/ query maximum client connections in TCP server mode
39	MID	Setting/ query module name
40	H	Query help message
(V4017 supporting command)		
41	AT+CFGTF	Save the current parameters as the default parameters
42	AT+PING	Ping automatically

Form5.3.3-1 AT Command

5.3.4. AT command

5.3.4.1. AT+E

Function: query/ setting module echo of the AT command setting

Format: query:

```
A+E<CR>
<CR><LF>+OK=< on/off ><CR><LF>
```

Setting:

```
A+E=< on/off ><CR>
<CR><LF>+OK<CR><LF>
```

Parameters: ON: enable the echo, echo the command entered by the AT command.

OFF: under AT command mode, the entered command do not echo.

E.g.: AT+E=on

5.3.4.2. AT+Z

Function: restart module

Format: setting:

```
AT+Z<CR>
<CR><LF>+OK<CR><LF>
```

Parameters: none

<note>: after perform this command correctly, module restart and exit the AT command mode.

5.3.4.3. AT+VER

Function: query module firmware version.

Format: query:

```
AT+VER<CR>
<CR><LF>+OK=< ver ><CR><LF>
```

Parameters: ver: query module firmware version.

5.3.4.4. AT+ENTM

Function: exit the AT command mode and enter the transparent transmission:

Format: setting:

```
AT+ENTM<CR>
<CR><LF>+OK<CR><LF>
```

Parameters: none

<note>: after perform this command correctly, module change into command mode from transparent transmission mode.

5.3.4.5. AT+RELD

Function: module reset

Format: setting

```
AT+RELD<CR>
<CR><LF>+OK<CR><LF>
```

Parameters: none.

5.3.4.6. AT+MAC

Function: query module MAC

Format: query:

```
AT+MAC<CR>
<CR><LF>+OK=< MAC ><CR><LF>
```

Parameters: mac: MAC address of the module(e.g.00020K2050A)

5.3.4.7. AT+USERMAC

Function: setting module customize MAC

Format: setting:

```
AT+USERMAC=<MAC><CR>
<CR><LF>+OK<CR><LF>
```

Parameters: mac: MAC address of the module, the first byte should be even, e.g. 002233445566

E.g.: AT+USERMAC=002233445566

5.3.4.8. AT+WEBU

Function: setting /query module username and password

Format: query:

```
AT+WEBU<CR>
<CR><LF>+OK=<username,password><CR><LF>
```

setting:

```
AT+WEBU=<username,password><CR>
<CR><LF>+OK<CR><LF>
```

Parameters: username: username, support 5 bytes at longest and can not be none:

password: password, support 5 bytes at longest.

E.g.: AT+WEBU=admin,admin

5.3.4.9. AT+WANN

Function: setting /query the IP of WAN(DHCP/STATIC) that module access

Format: query:

```
AT+WANN<CR>
<CR><LF>+OK=<mode,address,mask,gateway><CR><LF>
```

setting:

```
AT+WANN=<mode,address,mask,gateway><CR>
<CR><LF>+OK<CR><LF>
```

Parameters: mode: web IP mode (static/DHCP)

static: static IP/

DHCP: dynamic IP(address,mask,gateway parameters ignore)

Address: IP address

Mask: subnet masks

Gateway: gateway address

E.g.: AT+WANN=static,192.168.0.7,255.255.255.0,192.168.0.1

5.3.4.10. AT+DNS

Function: setting /query DNS server address:

Format: query:

```
AT+DNS<CR>
<CR><LF>+OK=<address><CR><LF>
```

setting:

```
AT+DNS=< address ><CR>
<CR><LF>+OK<CR><LF>
```

Parameters: **address:** DNS server address(default value is 208.67.222.222).

E.g.: AT+DNS=208.67.222.222

5.3.4.11. AT+WEBPORT

Function: setting /query webpage port

Format: query:

```
AT+WEBPORT<CR>
<CR><LF>+OK=< port ><CR><LF>
```

setting:

```
AT+WEBPORT=< port ><CR>
<CR><LF>+OK<CR><LF>
```

Parameters: **port:** module the port of the web server that built in of module. default 80:

E.g.: AT+WEBPORT=80

5.3.4.12. AT+UART

Function: setting /query UART interface parameters

Format: query:

```
AT+UART<CR>
<CR><LF>+OK=< baudrate,data_bits,stop_bit,parity,flowctrl ><CR><LF>
```

setting:

```
AT+UART=< baudrate,data_bits,stop_bit,parity,flowctrl ><CR><LF>
<CR><LF>+OK<CR><LF>
```

Parameters: **baudrate:** baud rate600~460800bps,can be customized .

data_bits: data 5/6/7/8

stop_bits: stop 1/2

parity: parity

- ◆ NONE(no parity)
- ◆ EVEN(even parity)
- ◆ ODD(odd parity)
- ◆ MASK(1 parity)
- ◆ SPACE(0 parity)

flowctrl: flow control(none flow control, can not setting , default setting to be the NFC)

- ◆ NFC: none: hardware flow control

E.g.: AT+UART=115200,8,1,NONE,NFC

5.3.4.13. AT+SOCK

Function: setting /query web protocol parameters format

Format: query:

```
AT+SOCK<CR>
<CR><LF>+OK=< protocol,IP,port ><CR><LF>
```

setting:

```
AT+SOCK=< protocol,IP,port ><CR>
<CR><LF>+OK<CR><LF>
```

Parameters:**Protocol:** protocol type, including

- ◆ TCPS is TCP server
- ◆ TCPC is TCP client
- ◆ UDPS is UDP server
- ◆ UDPC is UDP client
- ◆ HTPC is Httpd Client

IP: when the module setting into "CLIENT" mode, the IP address and domain name of the remote server.

Port: local port under Server mode and remote port under Client mode, decimal number and less than 65535.

E.g.: AT+SOCK=TCPC,192.168.0.201,8234

5.3.4.14. AT+TCPSE

Function: module is TCP Server, the processing mechanism after the connection reaches the maximum number of connections.

Format: query:

```
AT+TCPSE<CR>
<CR><LF>+OK=< status ><CR><LF>
```

setting:

```
AT+TCPSE=< status ><CR>
<CR><LF>+OK<CR><LF>
```

Parameters:

Status: setting status keep/kick

- ◆ keep: after reach the maximum number of connection, do not receive new one.
- ◆ kick: after reach the maximum number of connection, delete the order one and connect the new one.

E.g.: AT+TCPSE=keep

5.3.4.15. AT+SOCKLK

Function: query whether the TCP has connected

Format: query:

```
AT+ SOCKLK<CR>
<CR><LF>+OK=< sta ><CR><LF>
```

Parameters:

Sta: built the TCP connection or not

- ◆ Connect: TCP connected
- ◆ Disconnect: TCP not connected

5.3.4.16. AT+SOCKPORT

Function: setting /query local socket port

Format: query:

```
AT+SOCKPORT<CR>
<CR><LF>+OK=< sta ><CR><LF>
```

setting:

```
AT+ SOCKPORT =< sta ><CR>
<CR><LF>+OK<CR><LF>
```

Parameters:

- ◆ Sta: 0 is using port randomly. 1-65535 is using the local port of the socket.

E.g.: AT+SOCKPORT=20108:

5.3.4.17. AT+RFCEN

Function: enable/ disable RFC221 7function

Format: query:

```
AT+RFCEN<CR>
<CR><LF>+OK=< status ><CR><LF>
```

setting:

```
AT+RFCEN =< status ><CR>
<CR><LF>+OK<CR><LF>
```

Parameters:

Status:

- ◆ ON: enable RFC2217function
- ◆ OFF: disable RFC2217function

E.g.: AT+RFCEN=ON

5.3.4.18. AT+PDTIME

Function: query produce time

Format: query:

```
AT+PDTIME<CR>
<CR><LF>+OK=< time ><CR><LF>
```

Parameters:

time: produce time,

E.g.: 2016-10-18 11:20:02

5.3.4.19. AT+REGEN

Function: setting query registration package mechanism

Format: query:

```
AT+REGEN<CR>
<CR><LF>+OK=< status ><CR><LF>
```

setting:

```
AT+REGEN =< status ><CR>
<CR><LF>+OK<CR><LF>
```

Parameters:

Status:

- ◆ MAC: enable registration package mechanism, registration package is 6 bites MAC
- ◆ Usr: customize registration package
- ◆ Off: disable registration package mechanism

E.g.: AT+REGEN=MAC

5.3.4.20. AT+REGTCP

Function: setting query tcp client mode registration package perform mechanism

Format: query:

```
AT+REGTCP<CR>
<CR><LF>+OK=< status ><CR><LF>
```

setting:

```
AT+REGTCP =< status ><CR>
<CR><LF>+OK<CR><LF>
```

Parameters:

Status:

- ◆ first: send a registration package when connected the server at first time
- ◆ every: add a registration package in front of the every data package sent to server.
- ◆ all: send registration package when first connected to the server and add registration package in front of the data package.

E.g.: AT+REGTCP=first

5.3.4.21. AT+REGCLOUD

Function: setting /query USR-cloud username and password

Format: query:

```
AT+REGCLOUD<CR>
<CR><LF>+OK=< name, password ><CR><LF>
```

setting:

```
AT+REGCLOUD=< name, password ><CR>
<CR><LF>+OK<CR><LF>
```

Parameters:

Status:

- ◆ name: USR-cloud device port:
- ◆ password: USR-cloud password .

E.g.: AT+REGCLOUD=0000000000000000000000, 00000000

5.3.4.22. AT+REGUSR

Function: setting query customize registration package content

Format: query:

```
AT+REGUSR<CR>
<CR><LF>+OK=< data ><CR><LF>
```

setting:

```
AT+ REGUSR =< data ><CR>
```

<CR><LF>+OK<CR><LF>

Parameters:

data: ASCII code in 40 bytes

E.g.: AT+REGUSR=www.usr.cn

5.3.4.23. AT+HTPTP

Function: setting /query the asking way under HTTPD Client mode.

Format: query:

```
AT+HTPTP<CR>
<CR><LF>+OK=< status ><CR><LF>
```

setting:

```
AT+HTPTP =< status ><CR>
<CR><LF>+OK<CR><LF>
```

Parameters:

Status:

- ◆ GET: is the http asking way
- ◆ POST: is the http asking way

E.g.: AT+HTPTP=GET

5.3.4.24. AT+HTPURL

Function: setting /query Httpd 的 URL.

Format: query:

```
AT+HTPURL<CR>
<CR><LF>+OK=< URL ><CR><LF>
```

setting:

```
AT+HTPURL =< URL ><CR>
<CR><LF>+OK<CR><LF>
```

Parameters:

URL: start with “/”, less than 99 bytes .

E.g.: AT+HTPURL=/2.php

5.3.4.25. AT+HTPHEAD

Function: setting /query Httpd Client customize package head message

Format: query:

```
AT+HTPHEAD<CR>
<CR><LF>+OK=< data ><CR><LF>
```

setting:

```
AT+ HTPHEAD =< data ><CR>
<CR><LF>+OK<CR><LF>
```

Parameters:

- ◆ **data:** customize package message, less than 199 bytes. And using <<CRLF>> translating the characters in stead of the enter.

E.g.: AT+HTPHEAD=Accept:text<<CRLF>>

5.3.4.26. AT+HTPCHD

Function: setting /query filter the package head of the return information of Http

Format: query:

```
AT+ HTPCHD <CR>
<CR><LF>+OK=< sta ><CR><LF>
```

setting:

```
AT+ HTPCHD =< sta ><CR>
<CR><LF>+OK<CR><LF>
```

Parameters: Sta:

- ◆ ON: enable
- ◆ OFF: disable

E.g.: AT+HTPCHD=ON

5.3.4.27. AT+HEARTEN

Function: setting /query enable or not heartbeat package

Format: query:

```
AT+ HEARTEN <CR>
<CR><LF>+OK=< status ><CR><LF>
```

setting:

```
AT+ HEARTEN =< status ><CR>
<CR><LF>+OK<CR><LF>
```

Parameters:

Status:

- ◆ ON:enable heartbeat package
- ◆ Off: disable heartbeat package

E.g.: AT+HEARTEN=ON

5.3.4.28. AT+HEARTTP

Function: setting /query heartbeat package send way

Format: query:

```
AT+ HEARTTP <CR>
<CR><LF>+OK=< type ><CR><LF>
```

setting:

```
AT+ HEARTTP =< type ><CR>
<CR><LF>+OK<CR><LF>
```

Parameters:

Status:

- ◆ NET: send heartbeat package to server
- ◆ COM: send heartbeat package to serial port

E.g.: AT+HEARTTP=NET

5.3.4.29. AT+HEARTTM

Function: setting /query time of heartbeat package

Format: query:

```
AT+ HEARTTM <CR>
<CR><LF>+OK=< time ><CR><LF>
```

setting:

```
AT+ HEARTTM =< time ><CR>
<CR><LF>+OK<CR><LF>
```

Parameters:

Time: heartbeat time ,default is 30s, range from 1 to 65535s.

E.g.: AT+HEARTTM=30

5.3.4.30. AT+HEARTDT

Function: setting query customize heartbeat package content

Format: query:

```
AT+ HEARTDT <CR>
<CR><LF>+OK=< data ><CR><LF>
```

setting:

```
AT+ HEARTDT =< data ><CR>
<CR><LF>+OK<CR><LF>
```

Parameters:

data: less than 40 bytes ASCII code.

E.g.: AT+HEARTDT=www.usr.cn.

5.3.4.31. AT+ SCSLINK

Function: setting /query Socket connected status instructions function (connection status instructions pin change or not according to the connection status)

Format: query:

```
AT+ SCSLINK <CR>
<CR><LF>+OK=< sta ><CR><LF>
```

setting:

```
AT+ SCSLINK =< sta ><CR>
<CR><LF>+OK<CR><LF>
```

Parameters: sta: status

ON: enable link function

OFF: disable link function

E.g.: AT+ SCSLINK=ON

5.3.4.32. AT+ CLIENTRST

Function: setting /query TCP Client mode filed to connect several time and reset (repeat 30 times connection failed, module restart)

Format: query:

```
AT+ CLIENTRST <CR>
<CR><LF>+OK=< sta ><CR><LF>
```

setting:

```
AT+ CLIENTRST =< sta ><CR>
<CR><LF>+OK<CR><LF>
```

Parameters: sta: status

ON: enable TCP Client reset function

OFF: disable TCP Client reset function

E.g.: AT+CLIENTRST =ON

5.3.4.33. AT+ INDEXEN

Function: setting /query index function

Format: query:

```
AT+ INDEXEN <CR>
<CR><LF>+OK=< sta ><CR><LF>
```

setting:

```
AT+ INDEXEN =< sta ><CR>
<CR><LF>+OK<CR><LF>
```

Parameters: sta: status

ON: enable **index** function

OFF: disable **index** function

E.g.: AT+INDEX=ON

5.3.4.34. AT+ SOCKSL

Function: setting /query short connection function

Format: query:

```
AT+ SOCKSL <CR>
<CR><LF>+OK=< sta ><CR><LF>
```

setting:

```
AT+ SOCKSL =< sta ><CR>
<CR><LF>+OK<CR><LF>
```

Parameters: sta: status

ON: enable **short connection** function

OFF: disable short connection function

E.g.: AT+SOCKSL =ON

5.3.4.35. AT+ SHORTO

Function: setting /query short connection time

Format: query:

```
AT+ SHORTO <CR>
<CR><LF>+OK=< time ><CR><LF>
```

setting:

```
AT+ SHORTO =< time ><CR>
```

```
<CR><LF>+OK<CR><LF>
```

Parameters: time: short connection time, 2-255s

E.g.: AT+SHORTO =3

5.3.4.36. AT+ UARTCLBUF

Function: setting /query if the module clear the serial port cache before connected

Format: query:

```
AT+ UARTCLBUF <CR>
<CR><LF>+OK=< sta ><CR><LF>
```

setting:

```
AT+ UARTCLBUF =< sta ><CR>
<CR><LF>+OK<CR><LF>
```

Parameters: sta: status

ON: clear the serial port cache before connected

OFF: do not clear the serial port cache before connected

E.g.: AT+UARTCLBUF =ON

5.3.4.37. AT+ RSTIM

Function: setting /query restart out time

Format: query:

```
AT+ RSTIM <CR>
<CR><LF>+OK=< time ><CR><LF>
```

setting:

```
AT+ RSTIM =< time ><CR>
<CR><LF>+OK<CR><LF>
```

Parameters: time: short connection time: 0, 60-65535s

E.g.: AT+RSTIM =3600

5.3.4.38. AT+ MAXSK

Function: setting /query the maximum number of the client that TCP Server connected **Format: query:**

```
AT+ MAXSK <CR>
<CR><LF>+OK=< num ><CR><LF>
```

setting:

```
AT+ MAXSK =< num ><CR>
<CR><LF>+OK<CR><LF>
```

Parameters: num: the maximum number of the client that TCP Server connected, range from 1 to 16

E.g.: AT+MAXSK =4

5.3.4.39. AT+ MID

Function: setting /query module name

Format: query:

```
AT+ MID <CR>
```

```
<CR><LF>+OK=< name ><CR><LF>
```

setting:

```
AT+ MID =< name ><CR>
```

```
<CR><LF>+OK<CR><LF>
```

Parameters: name: module name, maximum 15 bytes and can not be none.

E.g.: AT+MID =USR-TCP232-T2

5.3.4.40. AT+ H

Function: help

Format: query:

```
AT+ H <CR>
```

```
<CR><LF>+OK=< sta ><CR><LF>
```

Parameters: sta: help information

5.3.4.41. AT+CFGTF

Function: save the current parameters as the default parameters

Format: query:

```
AT+ CFGTF <CR>
```

```
<CR><LF>+OK=< sta ><CR><LF>
```

Parameters: sta: saved: saved

5.3.4.42. AT+PING

Function: ping automatically.

Format: ping successful

```
AT+ PING=< IP ><CR>
```

```
<CR><LF>+OK=SUCCESS<CR><LF>
```

Ping out time

```
AT+ PING=< IP ><CR>
```

```
<CR><LF>+ERR=TIMEOUT<CR><LF>
```

Parameters: IP: remote IP or the domain name

E.g.: AT+PING=www.baidu.com

6.Contact us

Company: Jinan USR IOT Technology Co., Ltd

Address: Floor 11,Building1,No.1166 Xinluo Street,Gaoxin Distric,Jinan,Shandong,250101 China

Tel: 86-531-88826739 ext 829

Web: www.usriot.com

Support: <https://h.usriot.com>

Email: sales@usriot.com

7.Disclaimer

The document provides information about USR-TCP232-T2 module, it doesn't grant any license to the intellectual property rights. Except the responsibility declared in the product sale clause, USR does not assure any other responsibilities. In addition, USR does not make any warranties for the sale and use of this product, including the suitability of products for a particular purpose, merchant ability or fitness for any patent, copyright or other intellectual property infringement. USR may make changes to specifications and products description without notice.